

Computational Mechanics Tools

Assignment 3: Nonlinearity

Domenico Pice
05/01/2018

Sommario

1- Problem 1	3
1.2 - Model creation.....	3
1.2- Perfect elasticity case.....	4
1.3 - Perfect plasticity case with $f_y=460\text{MPa}$	5
1.4 - Hardening case with $f_{y2}=520\text{ MPa}$ and plastic strain equal to 0.005.....	6
1.5 - Hardening case with $f_{y2}=520\text{ MPa}$ and plastic strain equal to 0.002.....	7
1.6 – Comparisons	8
2 - Problem 2	9
2.1 – Model creation0.....	9
2.2 – Perfect elasticity case	10
2.3 – Plastic case, $f_y=900$, $\text{eps}_p=0$; $f_y=1000$, $\text{eps}_p=0.002$	11
2.4 - Plastic case, $f_y=320$, $\text{eps}_p=0$; $f_y=400$, $\text{eps}_p=0.005$	12
2.5 – Comparison.....	13

1- Problem 1

1.2 - Model creation

The objective of the homework is to create a model of a steel plate with a hole, which is submitted to axial tensile force.

To create the model the follow steps are complied:

- 1- Part creation
- 2- Material creation
- 3- Section creation
- 4- Instance and steps creation
- 5- Boundary conditions creation
- 6- Mesh creation
- 7- Set of points creation
- 8- Job creation and submission

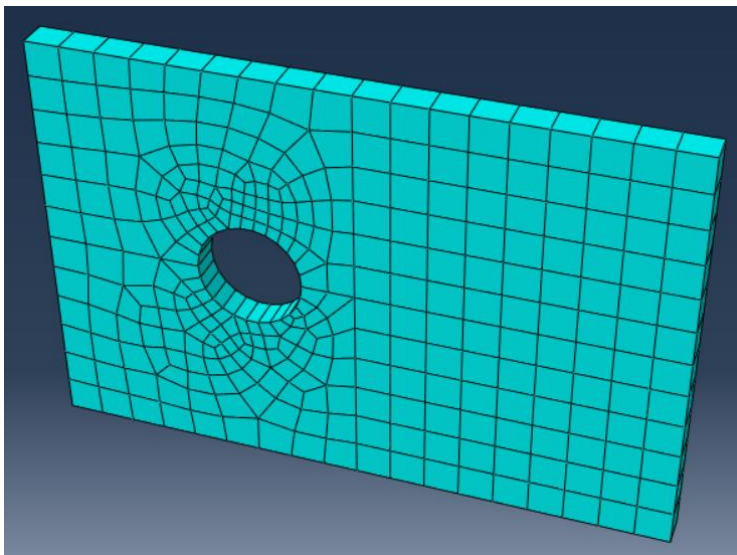
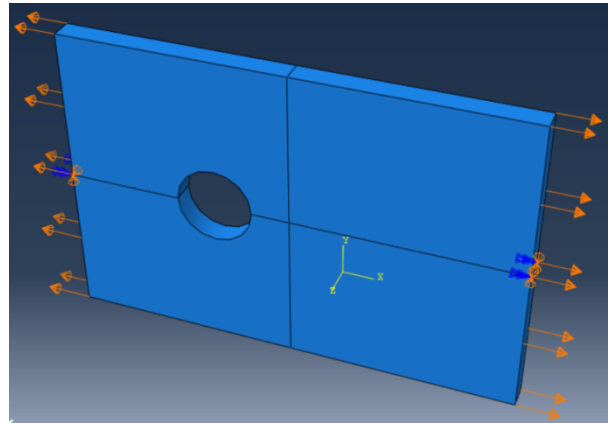
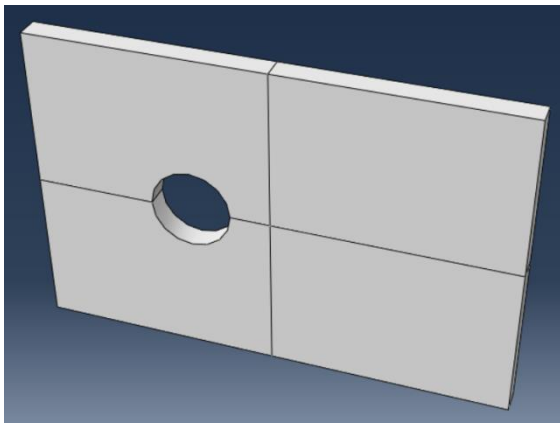

In these images are shown the geometrical model, the boundary condition and the mesh.

In order to study the different behaviors of the materials, 4 different problems area studied. For each case are reported 3 graphs. The first graph show the Von Mises Stress, the second display the force/time curve and the third illustrate the displacement/time relation.

1.2- Perfect elasticity case

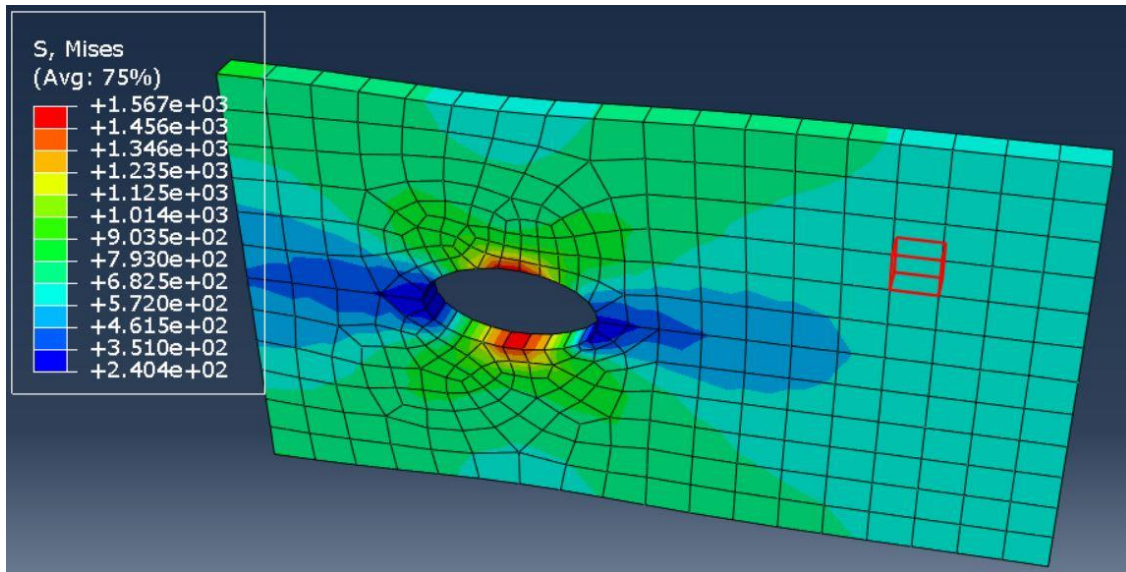

The yield limit of 640MPa is not overpassed.

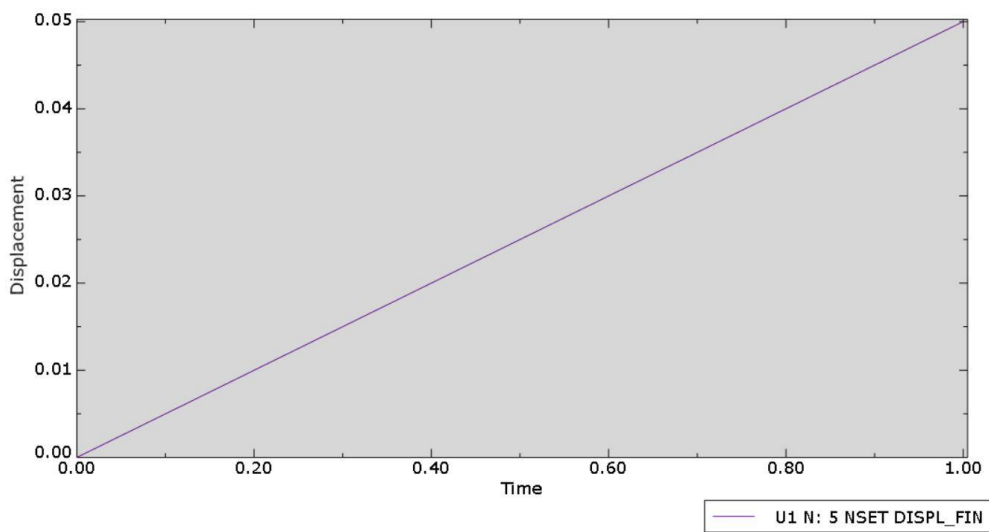
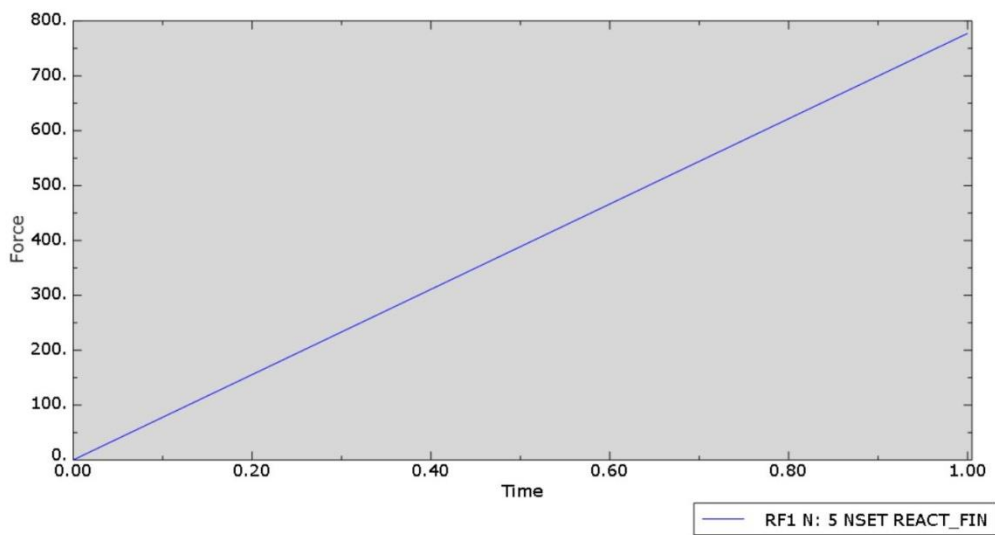

1.3 - Perfect plasticity case with $f_y=460\text{MPa}$

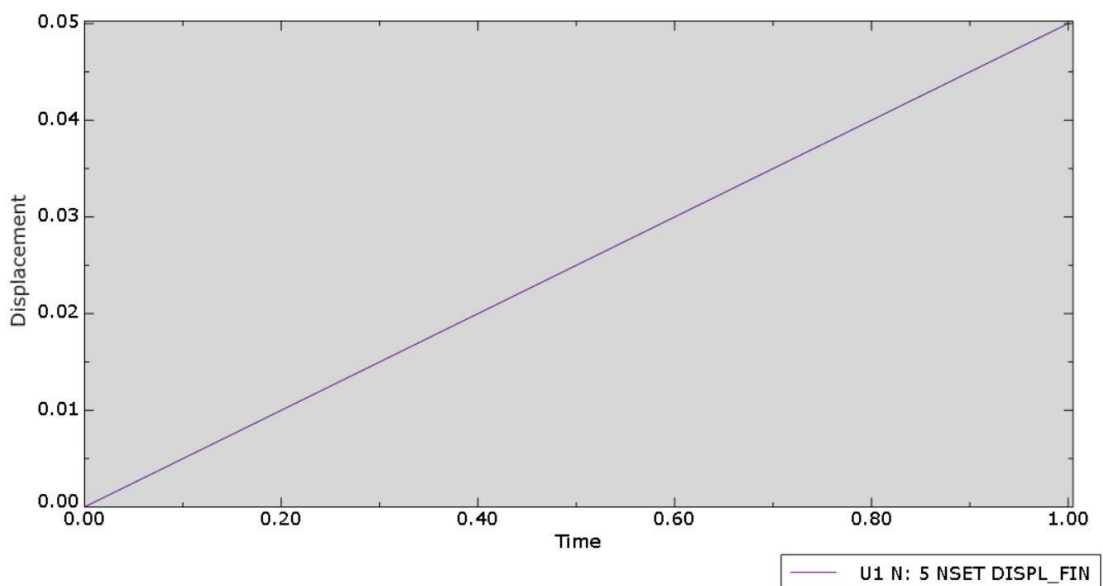
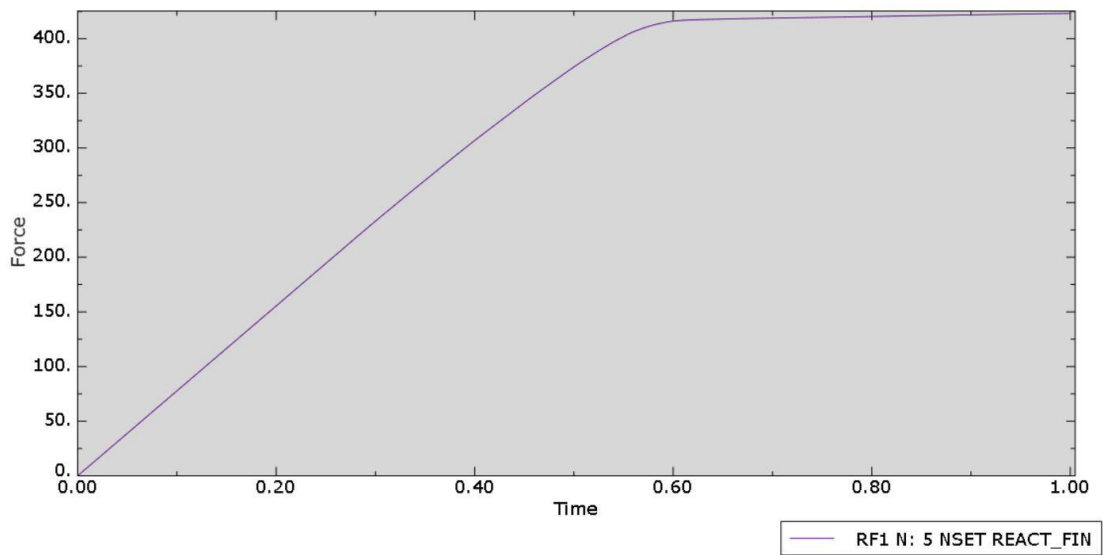
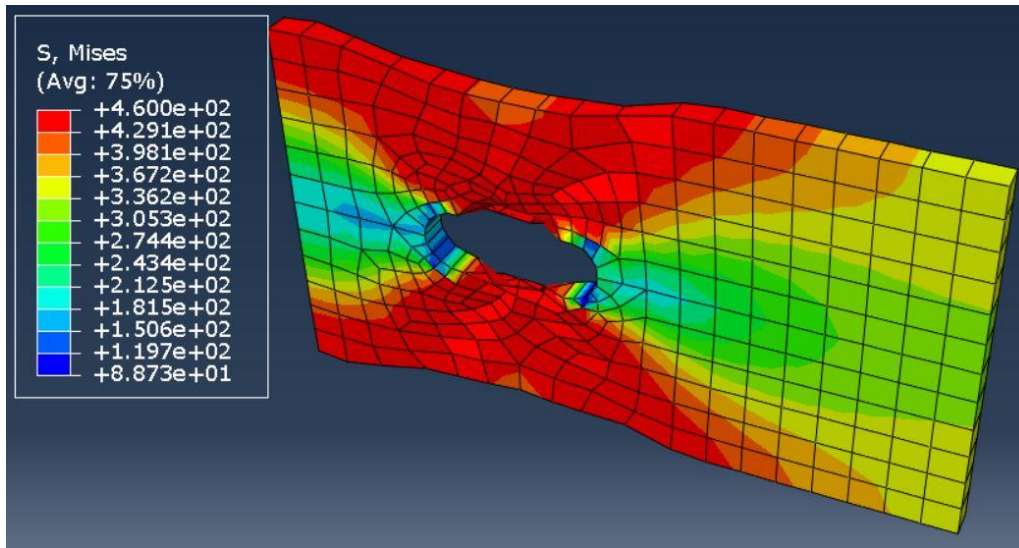

1.4 - Hardening case with $f_{y2}=520$ MPa and plastic strain equal to 0.005

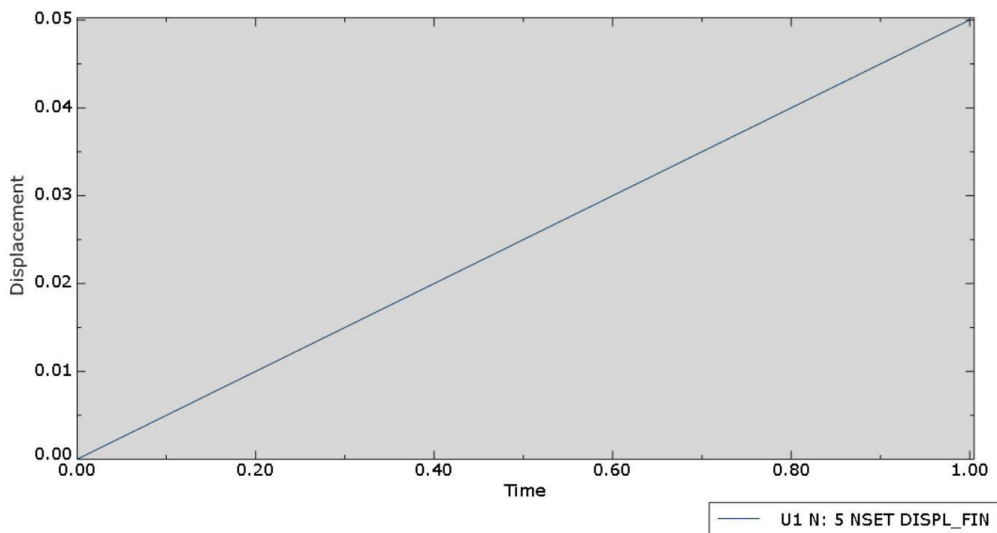
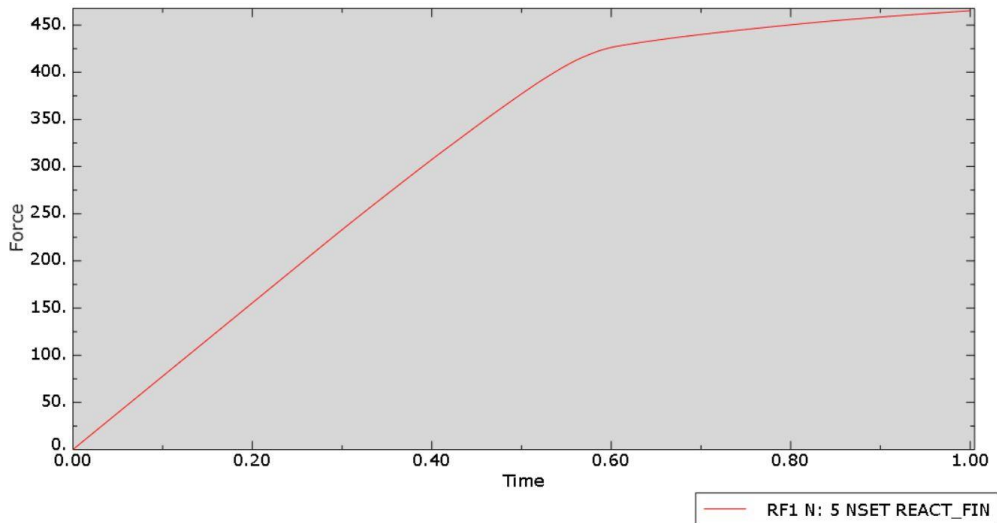
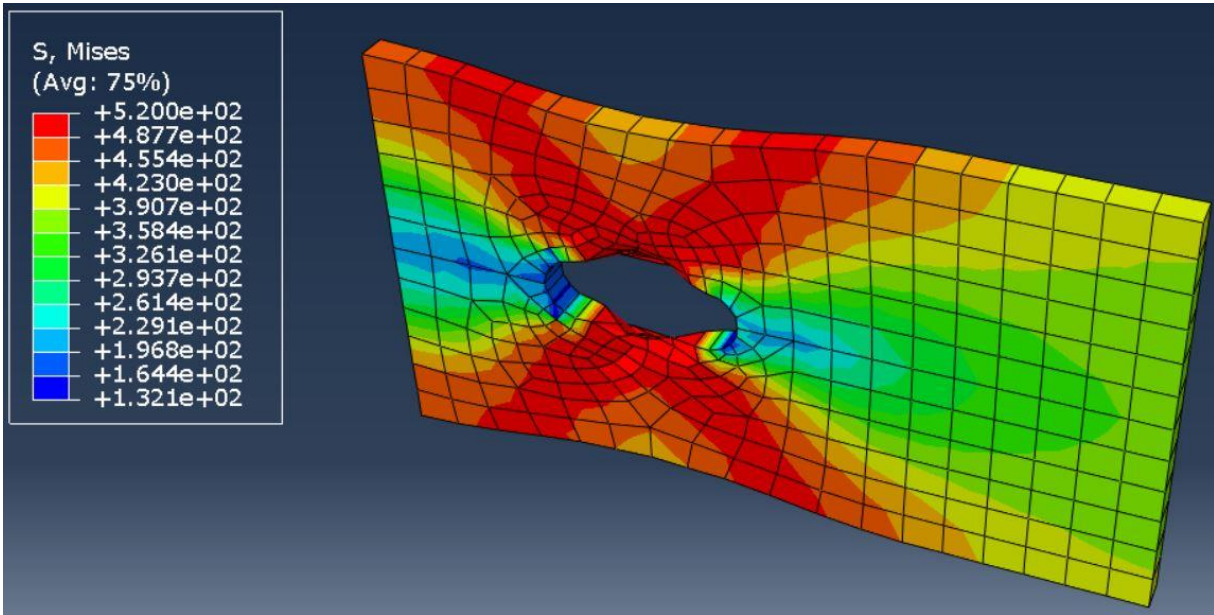

1.5 - Hardening case with $f_{y2}=520$ MPa and plastic strain equal to 0.002

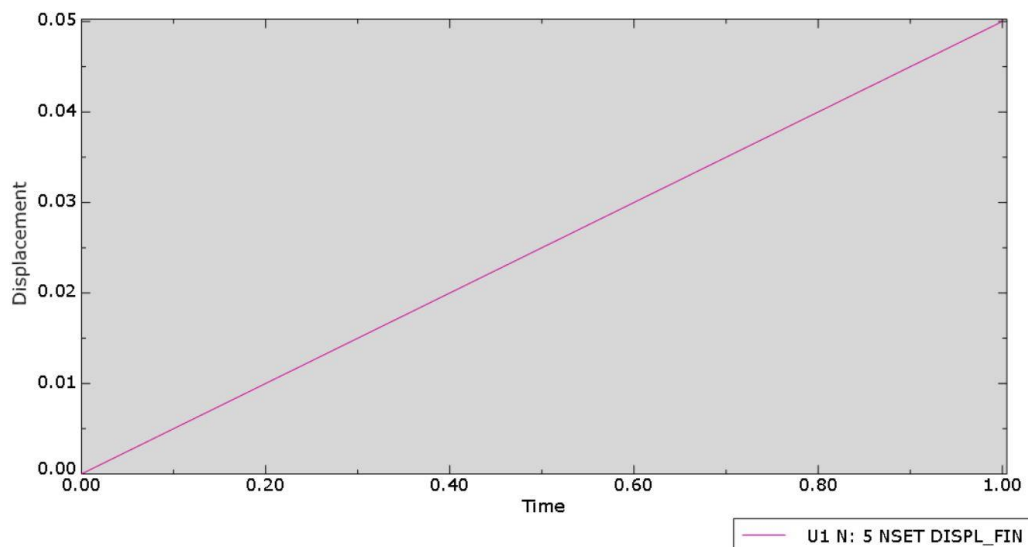
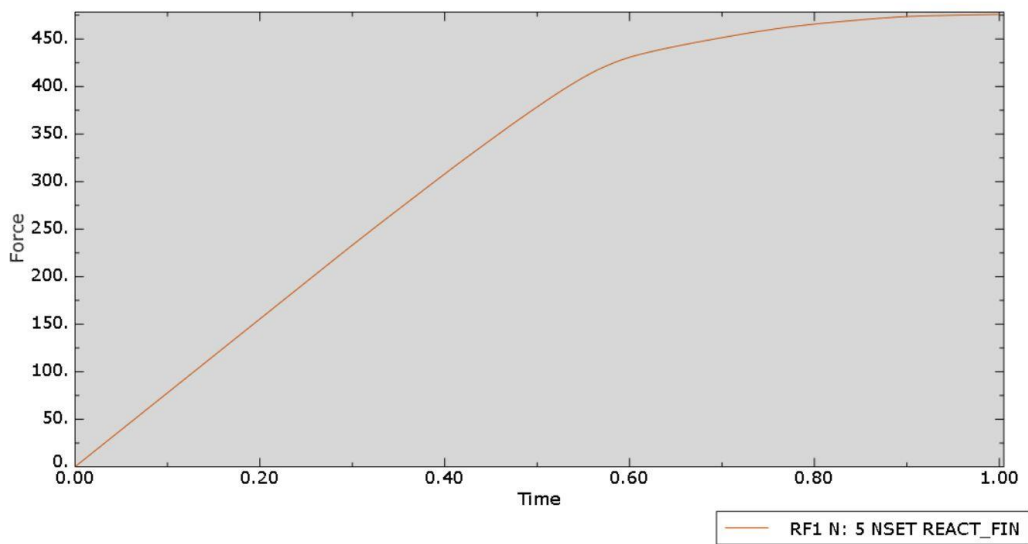
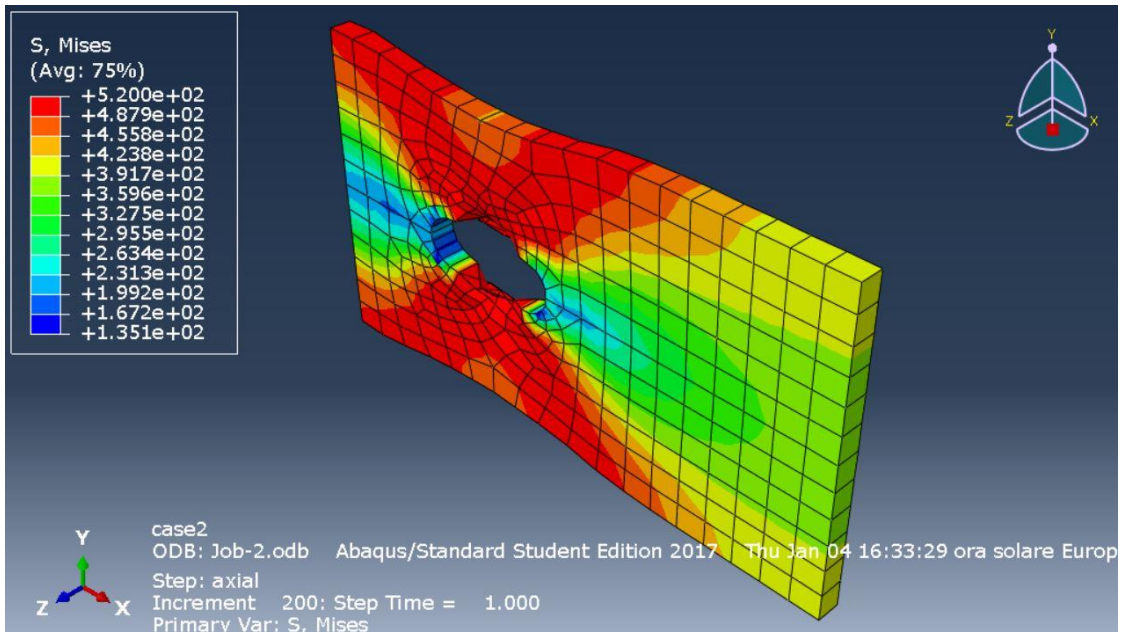

1.6 – Comparisons

In the following graph the comparison in terms of force/displacement, between all the cases, is shown.

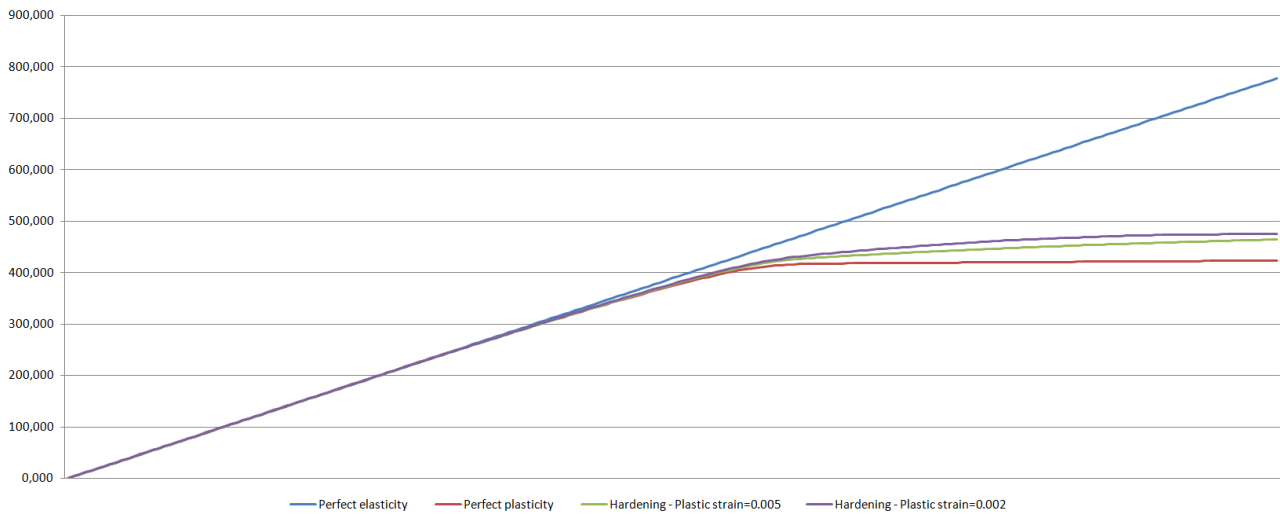

As we expect we see a linear dependence in the elastic case, indeed the blue line is a straight line: the proportionality between the load and the response of the system is confirmed.

As far as concern the other cases, we can notice an elastic behavior until the yield stress value. After this point each material have a different plastic part of the curve.

The perfect plasticity case have an horizontal straight line after the elastic part.

The 2 different hardening models shown 2 different behavior after the yield point. The slope of this curve is proportional to the plastic strain.

2 - Problem 2

2.1 - Model creation0

The second problem consists in the evaluation of the stress of the steel plate with a pin insert in the hole. This pin is fixed and it cannot move. In order to study this problem, thanks to the symmetry, only an half of the plate is studied.

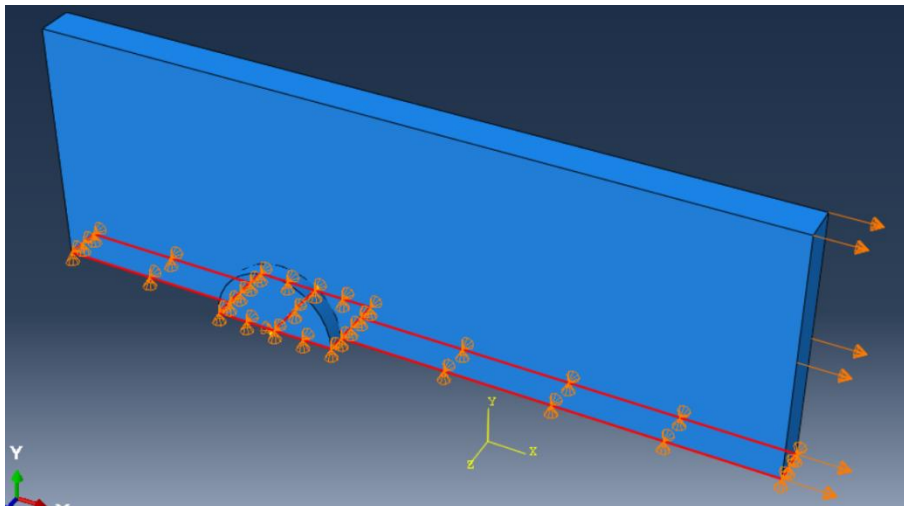
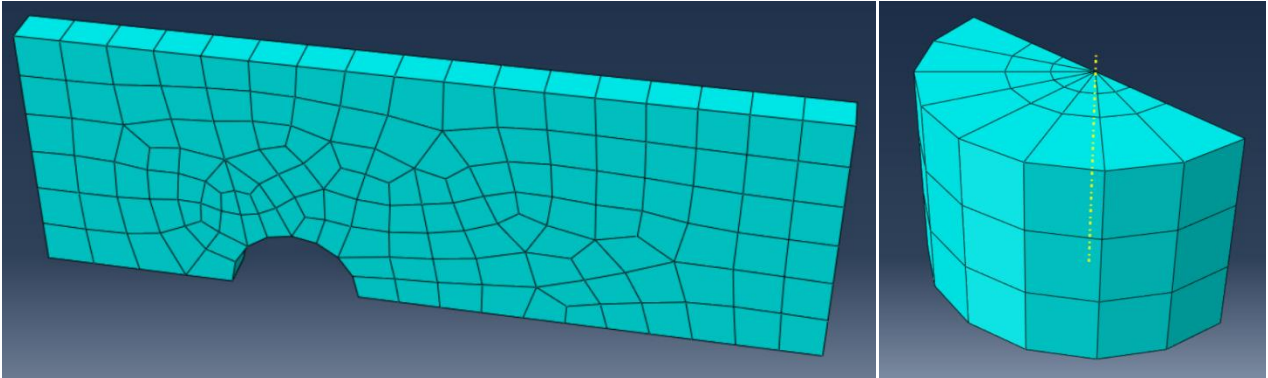

In the previous images are displayed the meshes of the 2 different parts and the boundary conditions.

Different cases are studied. In particular, in this problem, the steel plate material properties are constant (hardening case with plastic strain equal to 0.005), while the pin material property changes for each case.

For each case are reported 3 graphs. The first graph show the Von Mises Stress, the second demonstrate the force/time curve and the third illustrate the displacement/time curve. Moreover, a factor of amplitude equal to 10 is applied. Finally, the stress values higher than 460 MPa are plotted in dark red.

2.2 - Perfect elasticity case

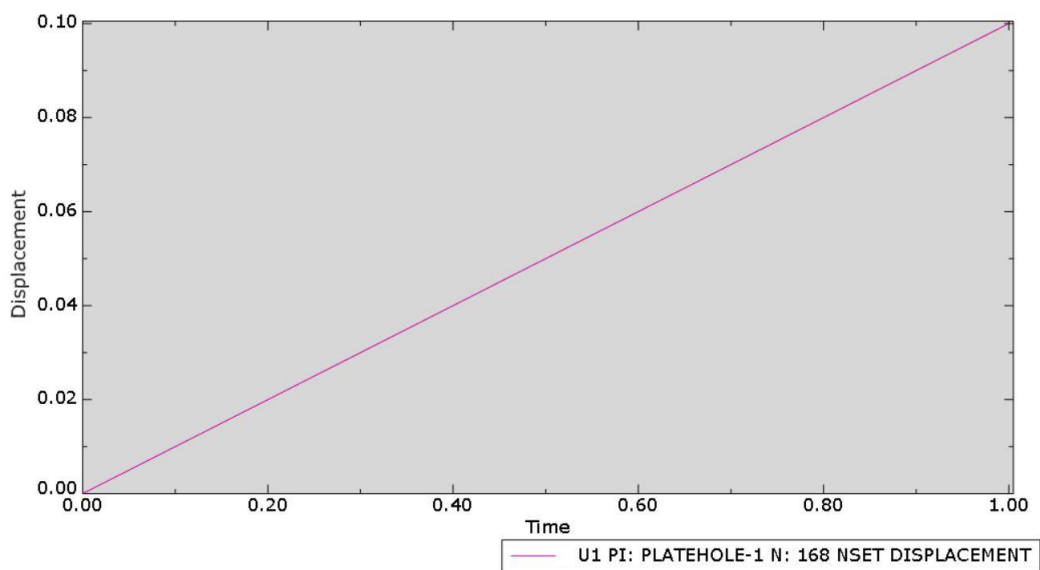
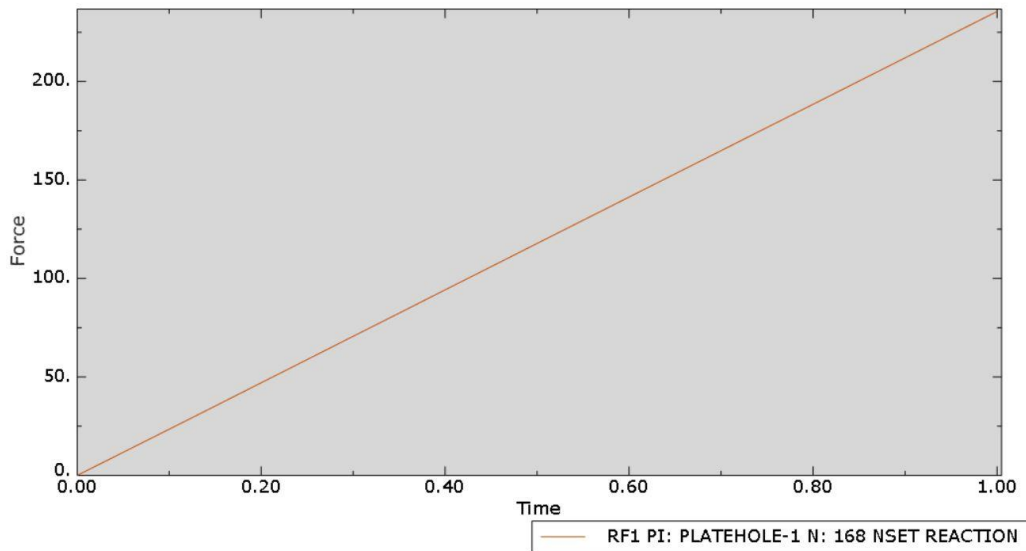
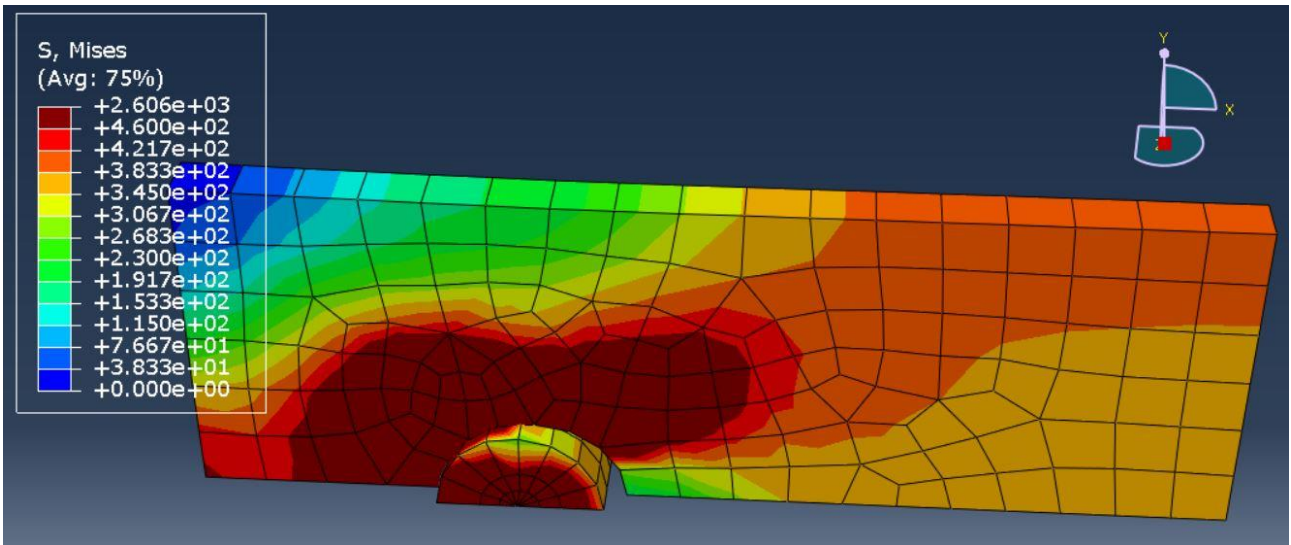

2.3 - Plastic case, $f_y=900$, $\epsilon_p=0$; $f_y=1000$, $\epsilon_p=0.002$

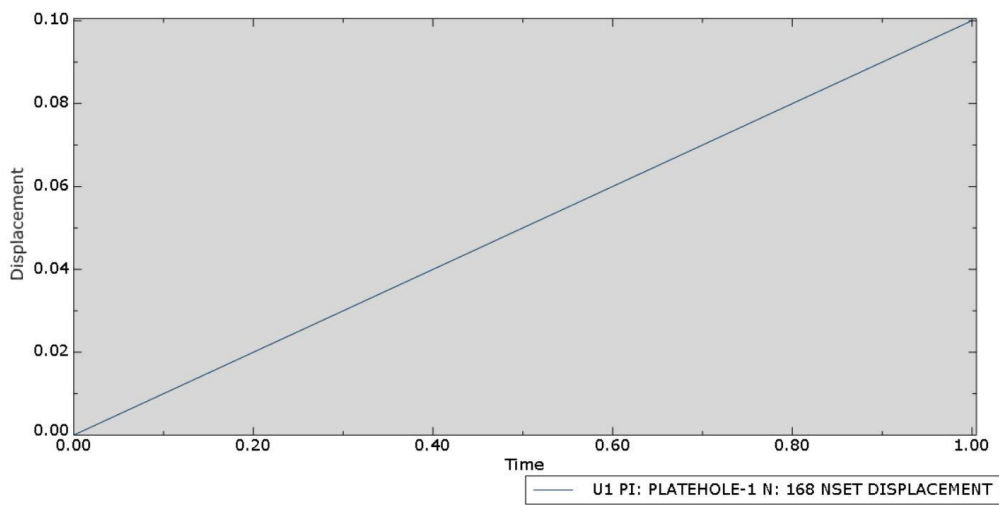
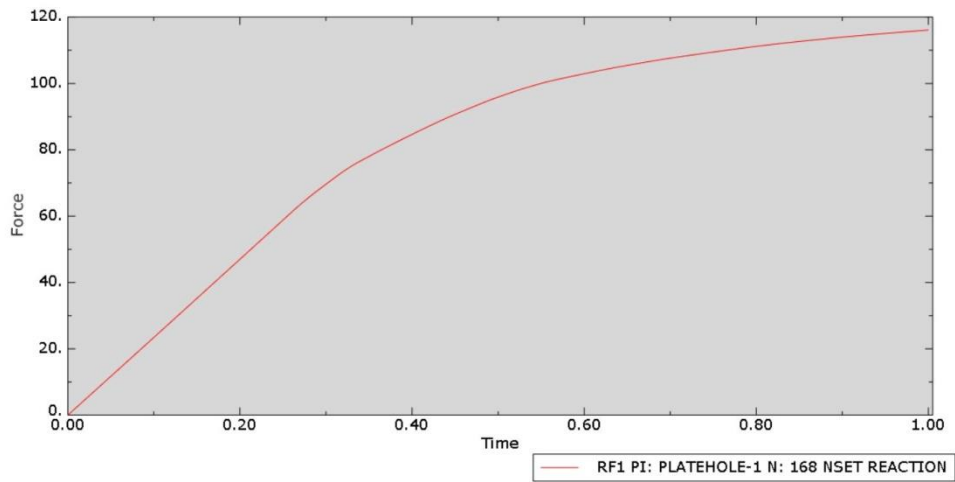
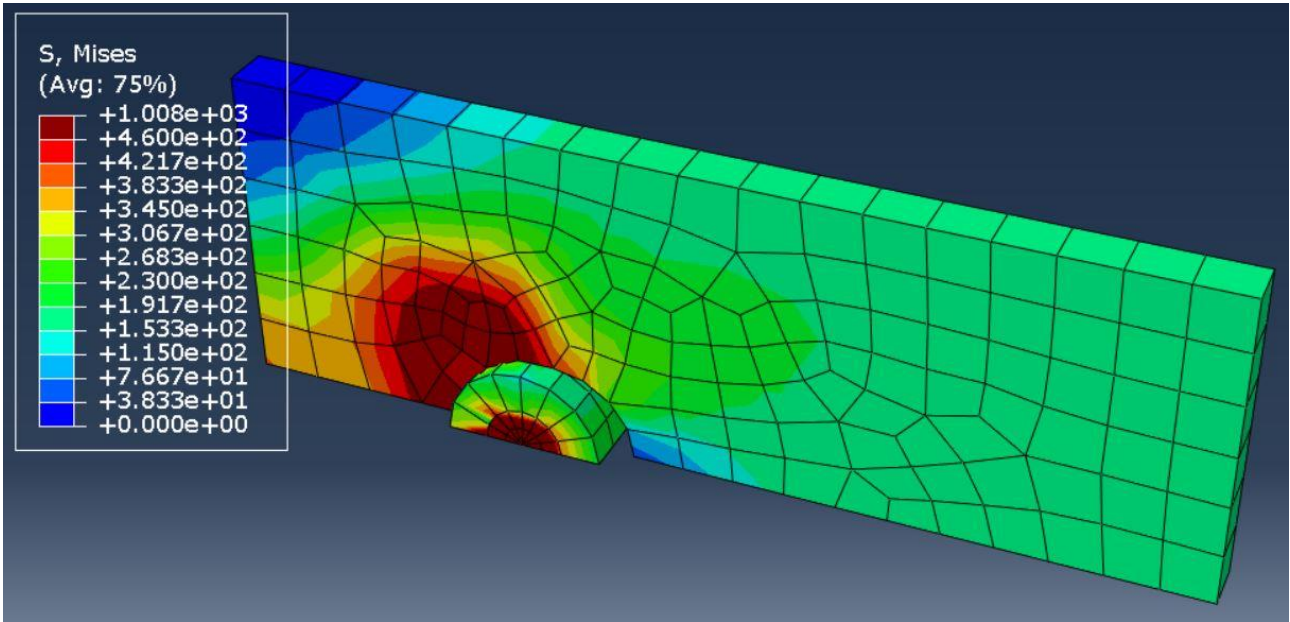

2.4 - Plastic case, $f_y=320$, $\epsilon_p=0$; $f_y=400$, $\epsilon_p=0.005$

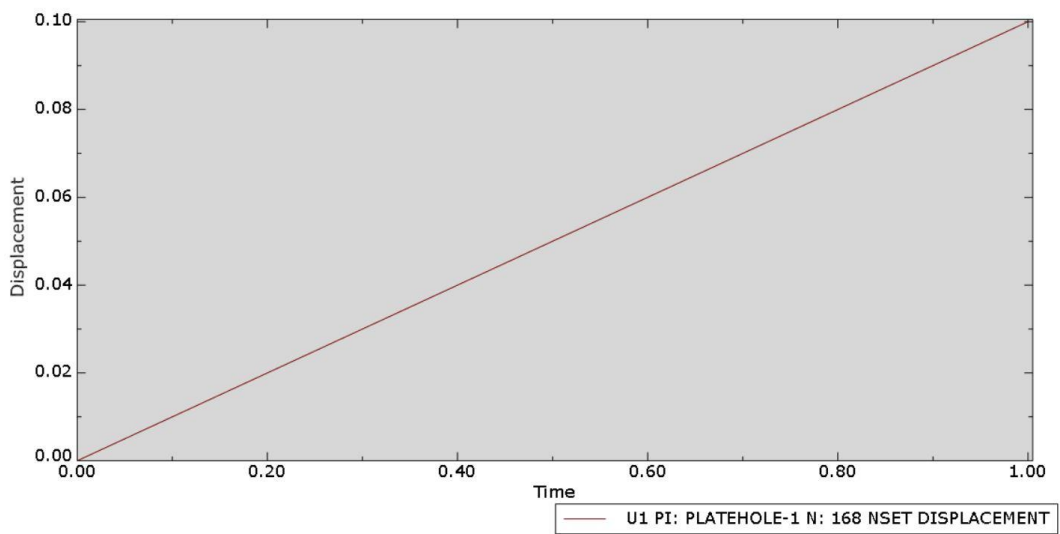
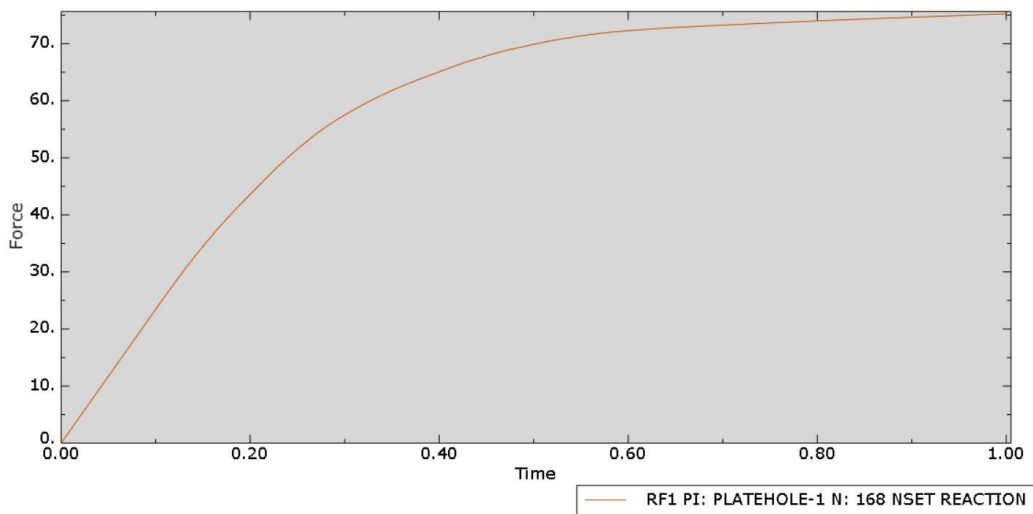
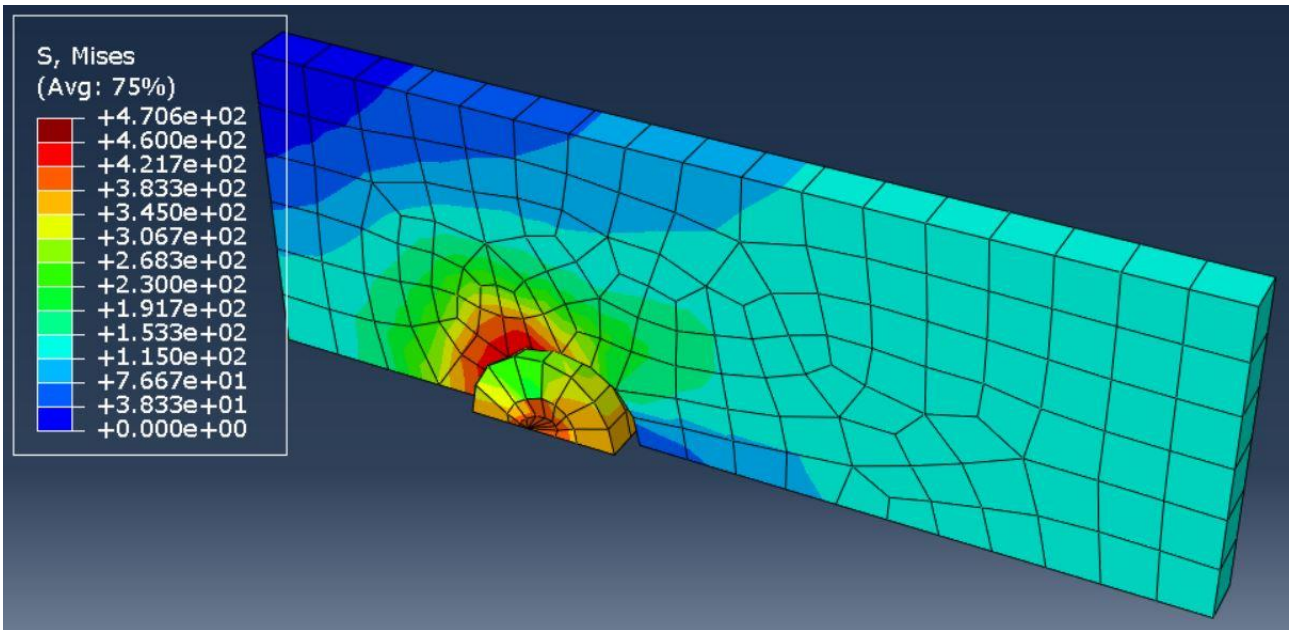

2.5 – Comparison

A comparison in terms of force/displacement diagram is shown below.

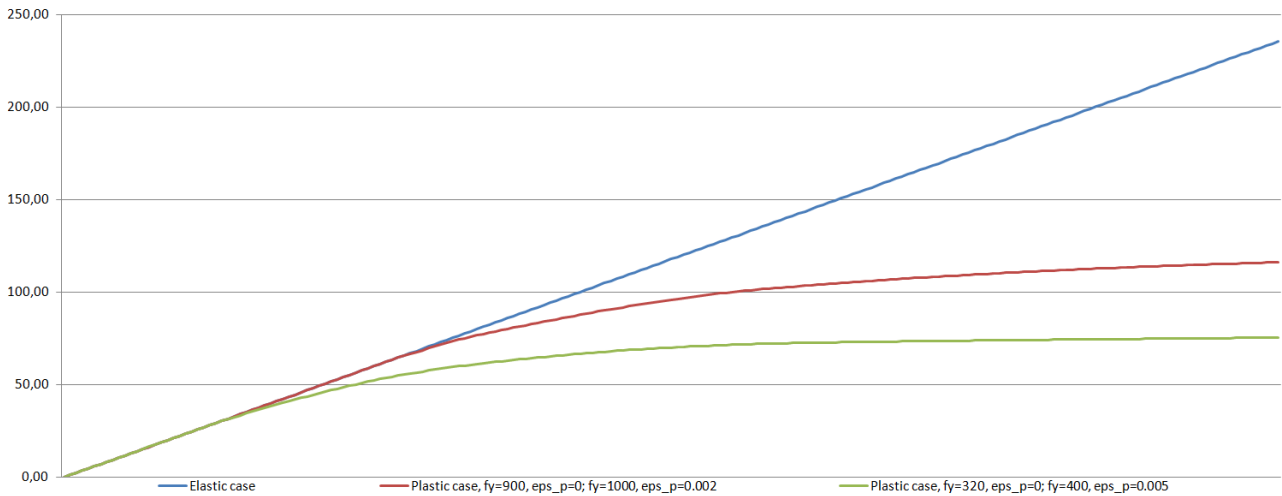

The elastic study shows that a big part of the plate and the pin are damaged. The dark red part is extended all around the pin. The material is not able to resist to the stress applied.

On the other hand, using a plastic property for the pin, the dark red spot diminishes. This happens because the pin is deformed after a certain value of stress, and the stress is lower even in the plate. This is explained by the fact that part of the energy is dissipated in the plastic deformation.

Giving the material an higher yield stress value means give higher stiffness and the plastic behavior appears later. In each plastic case we can notice the hardening behavior because the force trend is increasing.