

Master on Numerical Methods in Engineering and  
Programme in Computational Mechanics

Ediz Karaali

Practice 1

**Problem 1.**

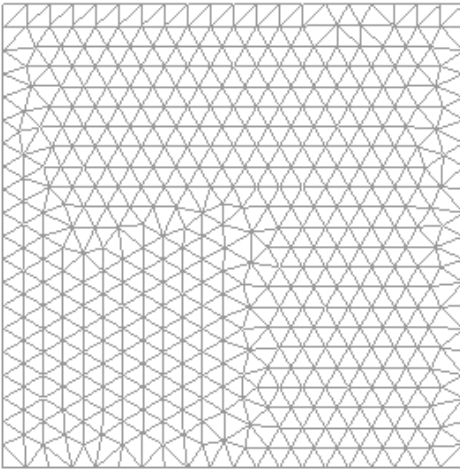

Fig 1. Triangular Elements with Three Nodes

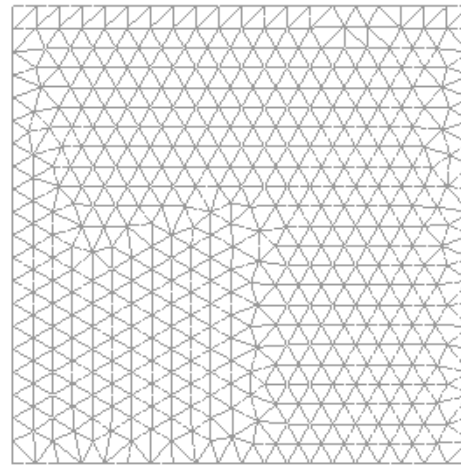

Fig 2. Triangular Elements with Six Nodes

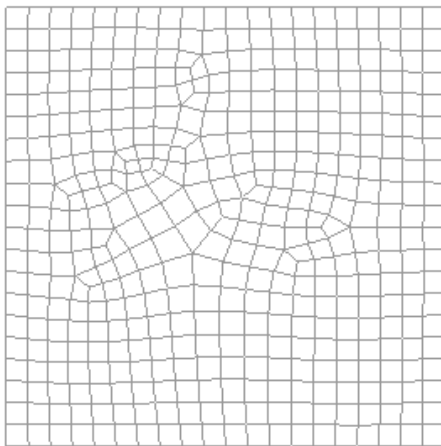

Fig 3. Quadrilaterals with Four Nodes

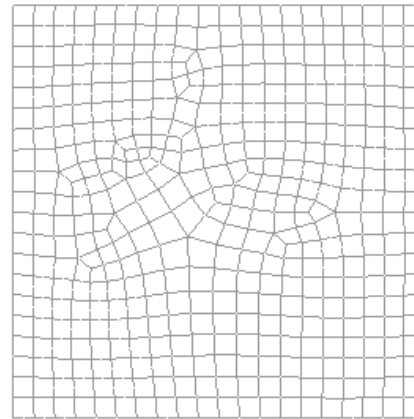

Fig 4. Quadrilaterals with Eight Nodes

Table1. Comparable Results of Different Meshes

	Number of triangle/quadrilateral elements	Number of nodes
Triangular Element with 3 nodes	882	482
Triangular Element with 6 nodes	882	1845
Quadrilaterals with 4 nodes	421	462
Quadrilaterals with 8 nodes	421	1344
Quadric 9	421	1765

-Size of elements to be generated is chosen as 0.1

**Problem 2.**

a. Geometry of the structure

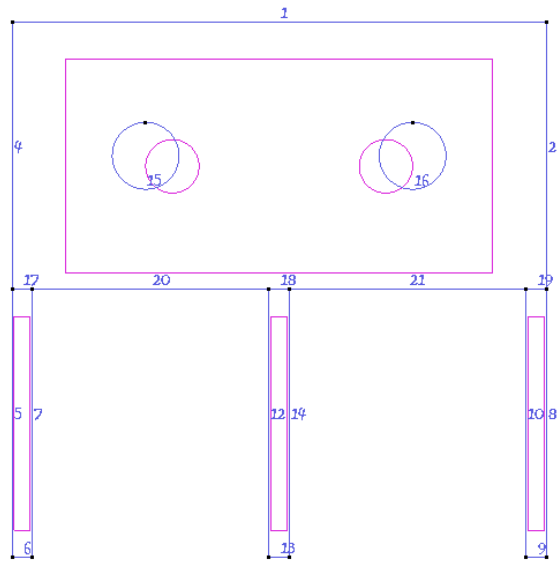

Fig 5. Geometry of Structure with Surfaces

b. Problem Data, Boundary Conditions and Loads

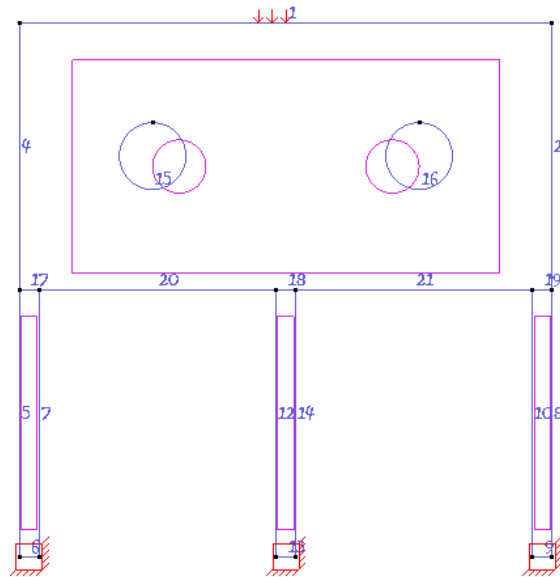

Fig 6. Constraints for Case 1

c. Mesh

Triangular elements with 3 nodes are used to generate mesh. Number of triangle elements and number of nodes are respectively the following: 7793 and 4198. Size of elements to be generated is used as 0.1

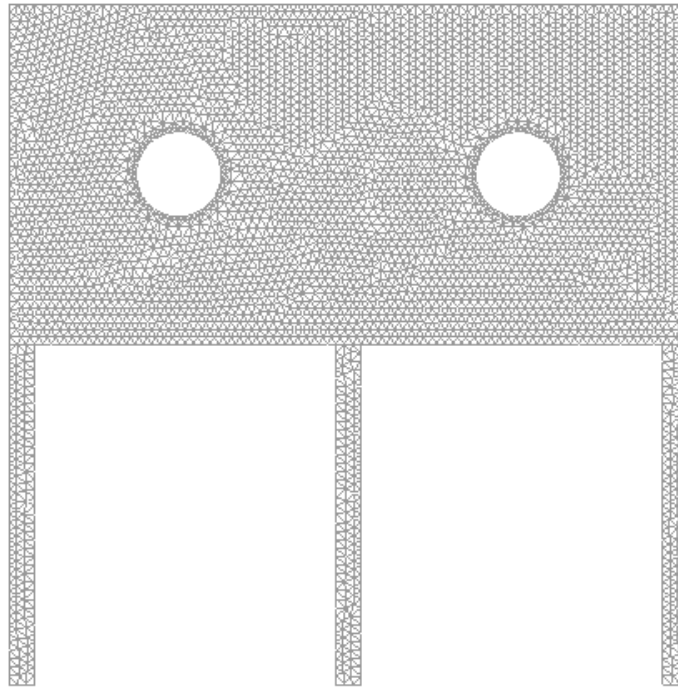
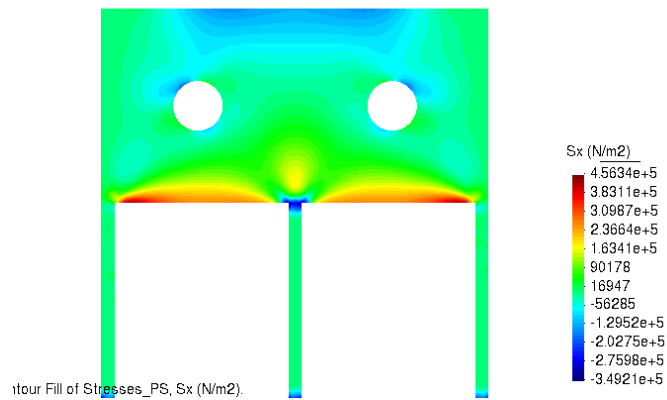
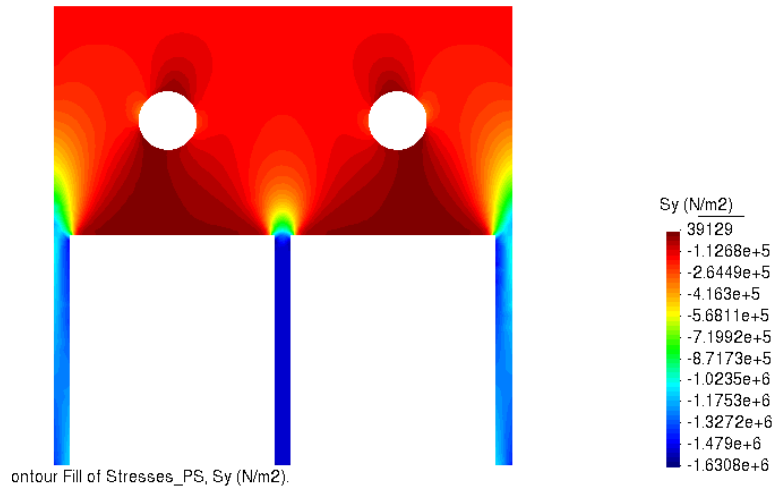

Fig 7. Geometry with Mesh

d. Results and Discussion

Case1. Dead Weight + Uniform Load





Contour Fill of Stresses\_PS,  $S_y$  (N/m<sup>2</sup>).

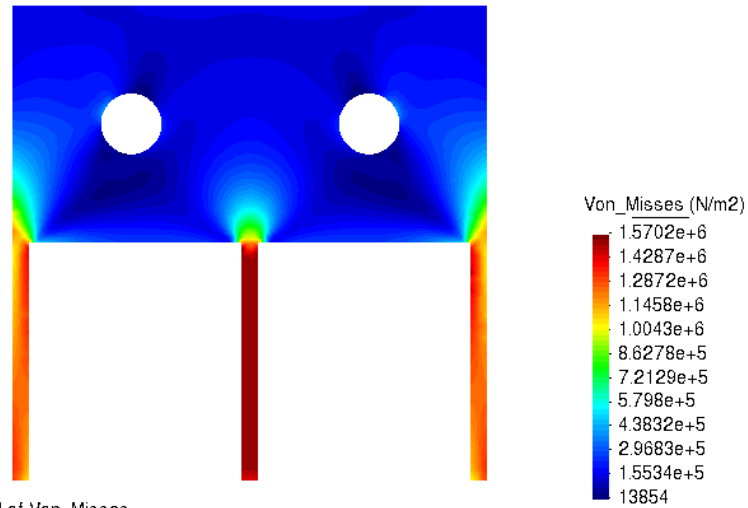

Contour Fill of Von\_Mises.

Case2. Dead Weight + Uniform Load + Settlement of the Central Column

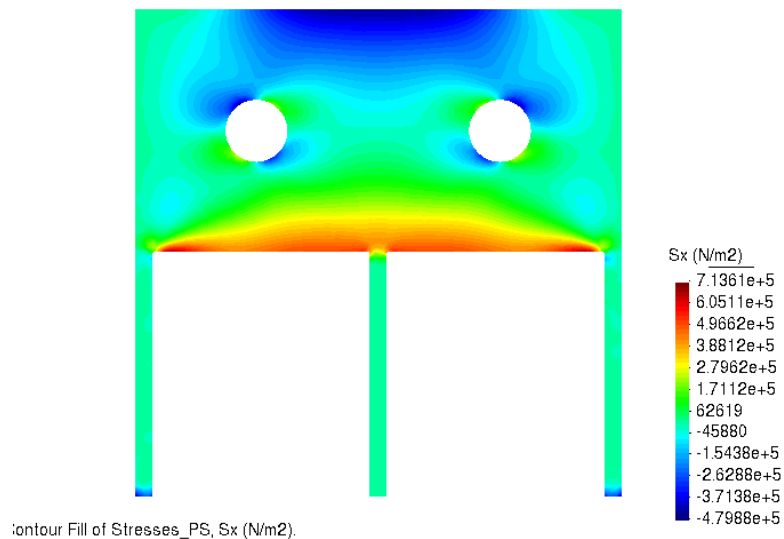

Contour Fill of Stresses\_PS,  $S_x$  (N/m<sup>2</sup>).

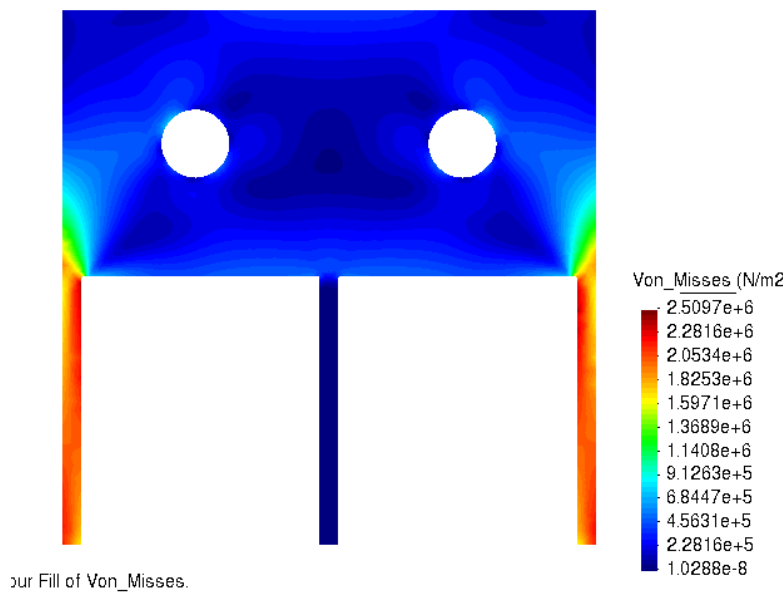
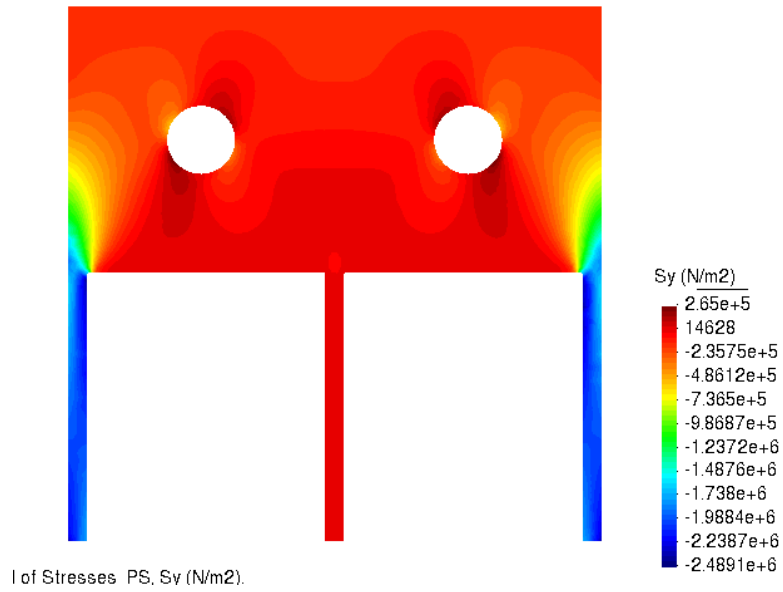

**Problem 3.**

a. Geometry and materials



- Steel
- Concrete

b. Mesh

-Size of elements to be generated is 0.05.

-Number of Quadrilateral Elements = 1173

-Number of Nodes = 1297

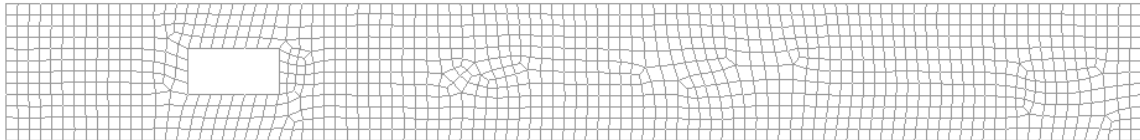

c. Postprocess

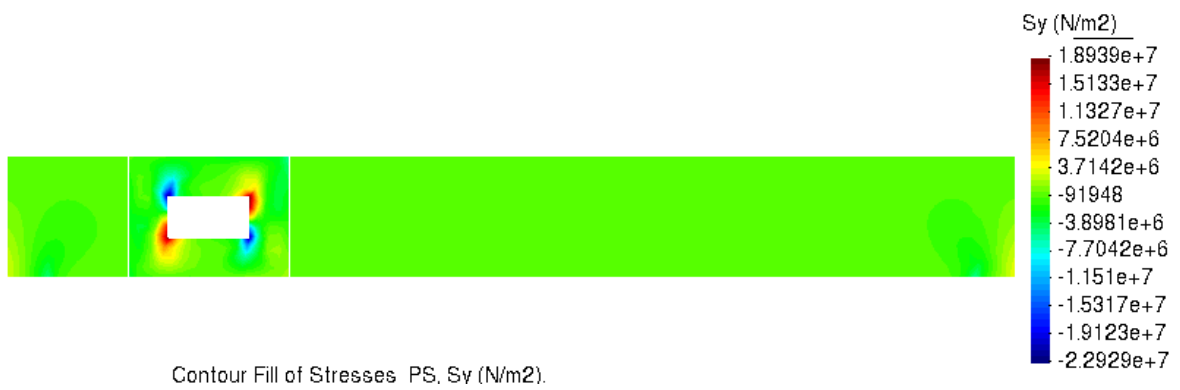
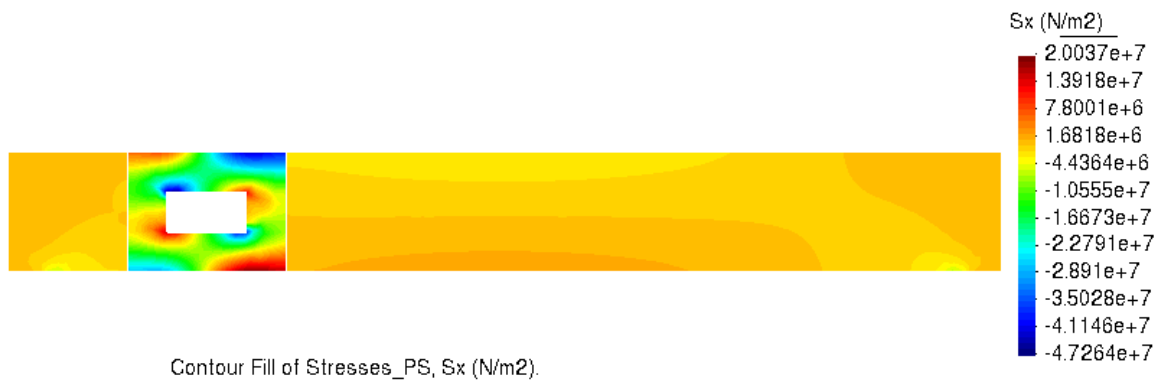

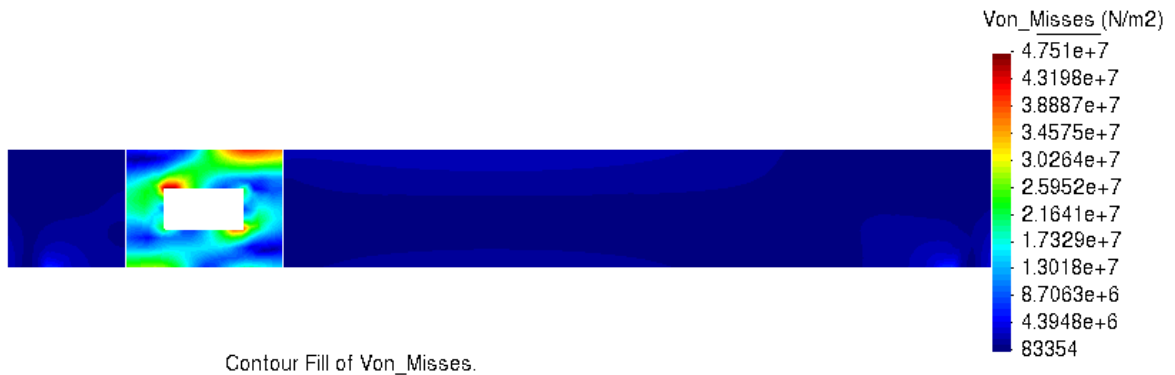

-Displacements:

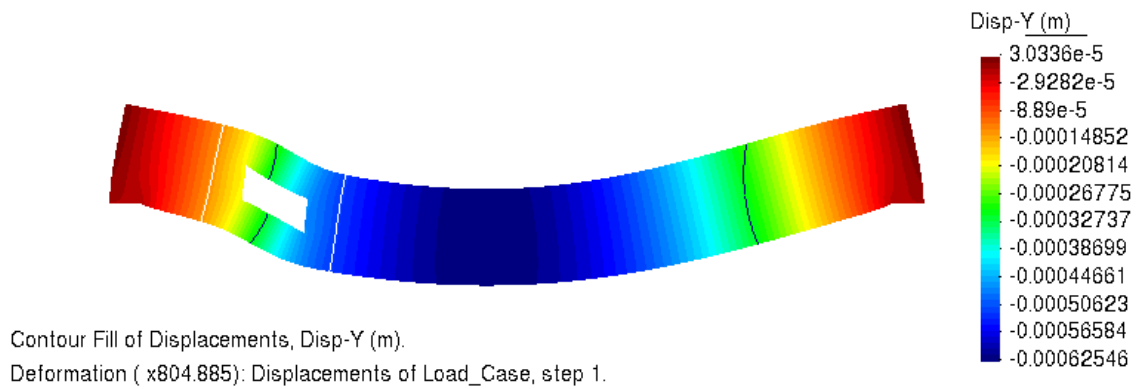
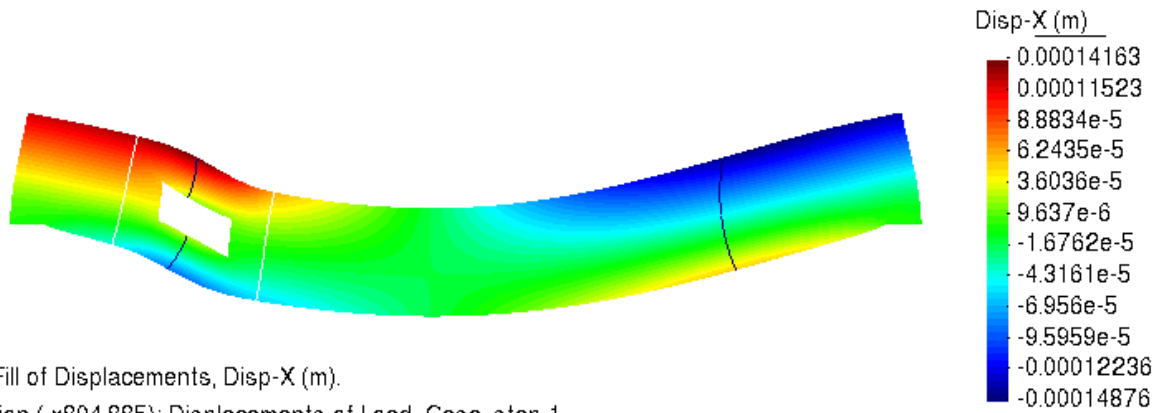



Problem 4.