Computational Structural Mechanics and dynamics

GID

Practice 1

Submitted by

ANQI LI

ARADA JAMNONGPIPATKUL

Erasmus Mundus Program

MSc Computational Mechanics

Universitat Politècnica de Catalunya, BarcelonaTECH

9 March 2017

Contents

1	Exercise 1: Thin plate under dead weight	1
1.1	Introduction	1
1.2	Results	1
1.3	Result comparisons	2
2	Exercise 2: Plate with two sections	4
2.1	Introduction	4
2.2	Stress distribution	4
3	Exercise 3: Plate with ventilation hole	6
3.1	Introduction	6
3.2	Stress distribution	6
4	Exercise 4: Prismatic water tank	8
4.1	Introduction	8
4.2	Displacement distribution	8
4.3	Stress distribution	9
A	Exercise 1: Thin plate under dead weight	11

1 Exercise 1: Thin plate under dead weight

1.1 Introduction

In Figure 1.1, the thin plate is submitted to its self weight. Edge AC is restricted in direction y and point B fixed. The dimensions of the plate is given in Figure 1.1. The material data is also given below. Triangular elements with 3 and 6 nodes and quadrilateral elements with 4, 8 and 9 nodes were used in the analysis.

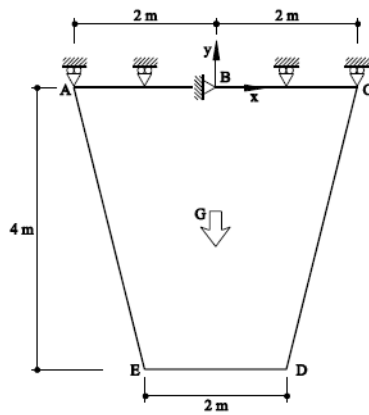

Material
 $E = 2.1 \times 10^5 \text{ MPa}$
 $\nu = 0.03$
 $\gamma = 7000 \text{ kg/m}^3$
 $\text{thickness} = 0.01 \text{ m}$

Figure 1.1: Thin plate under dead weight

1.2 Results

Displacement and stress contours in the y-direction when using triangular elements with 3 nodes and when using quadrilateral elements with 4 nodes are shown in Figure 1.2 and Figure 1.3, respectively. The contours when using other types of elements can be found in Appendix A.

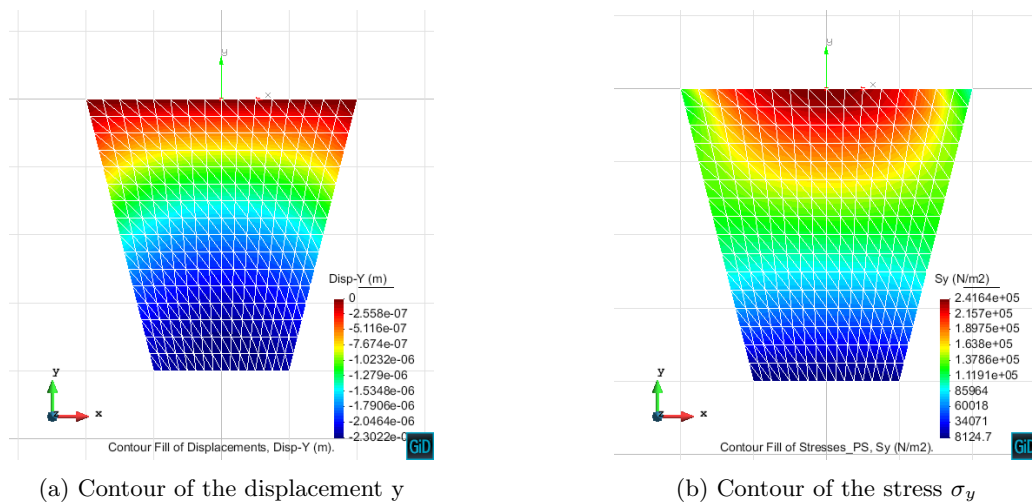

Figure 1.2: Results when using triangular elements with 3 nodes

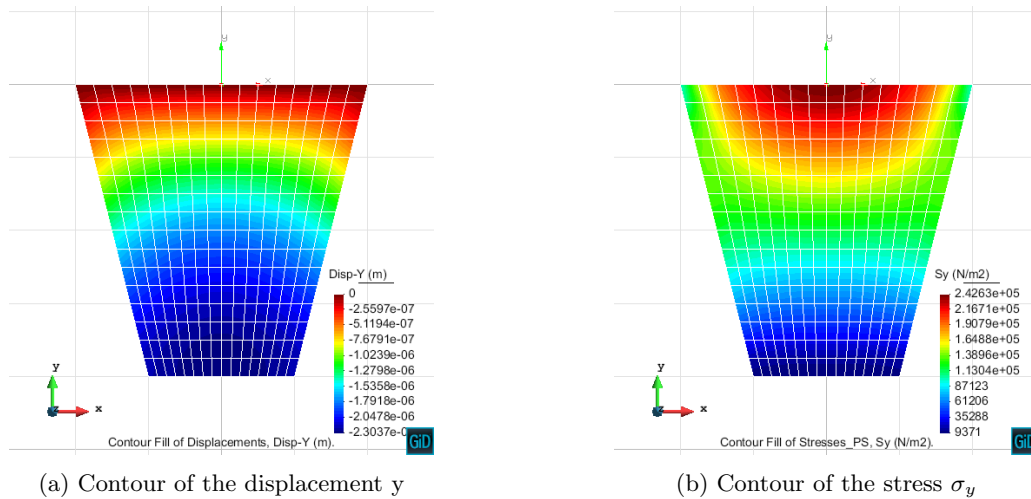

Figure 1.3: Results when using quadrilateral elements with 4 nodes

1.3 Result comparisons

Displacement y at the center of side ED and stress σ_y at point B obtained by using different types of elements are shown in Table 1.1. These numbers from the analysis were compared with the provided sought solutions yielding the percentage of error also shown in the table.

For each type of element, number of elements used in the analysis were varied to study the convergence rate. The convergence rate is compared among different types of elements. In Figure 1.4, the convergence rates are shown in term of the absolute values while the convergence rates are shown in term of the percentage of result errors in Figure 1.5.

From Table 1.1, Figure 1.4 and Figure 1.5, it can be seen that the quadratic elements converge faster than the linear elements and the quadrilateral element gives less error than the triangular element when the meshes are not very redefined. Overall, the obtained results are pretty accurate.

Table 1.1: Displacement y and stress σ_y

Element type	Number of elements per line	Displacement y at the center of side ED	Stress σ_y at point B	Error of disp- y	Error of σ_y
Triangle element with 3 nodes	16	$2.302 \times 10^{-6}m$	0.242 MPa	1.87%	2.02%
Triangle element with 6 nodes	16	$2.302 \times 10^{-6}m$	0.242 MPa	1.87%	2.02%
Quadrilateral element with 4 nodes	16	$2.304 \times 10^{-6}m$	0.243 MPa	1.93%	1.62%
Quadrilateral element with 8 nodes	16	$2.304 \times 10^{-6}m$	0.250 MPa	1.93%	1.21%
Quadrilateral element with 9 nodes	16	$2.304 \times 10^{-6}m$	0.250 MPa	1.93%	1.21%

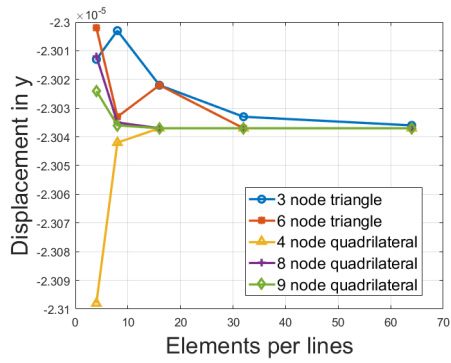

(a) Displacement y at the center of side ED

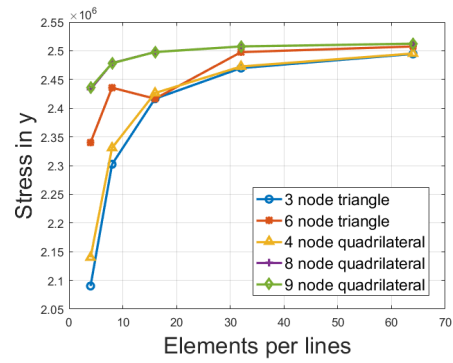

(b) Stress σ_y at point B

Figure 1.4: Convergence rate in term of the absolute values

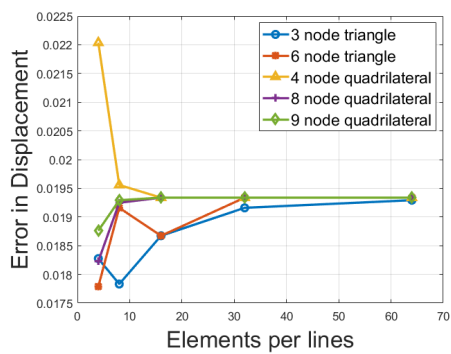

(a) Error in displacement y at the center of side ED

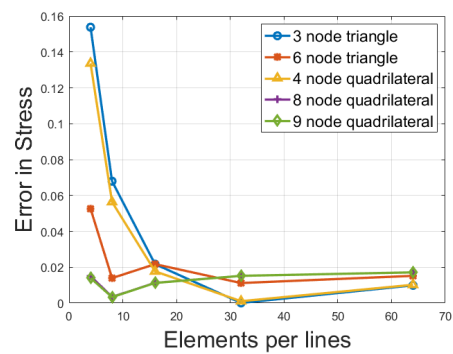

(b) Error in stress σ_y at point B

Figure 1.5: Convergence rate in term of result errors

2 Exercise 2: Plate with two sections

2.1 Introduction

In Figure 2.1, a reinforced concrete plate with two holes is supported by three columns. The central column undergoes a displacement δ . The top of concrete plate is subjected to a uniform load. The dimensions of the plate is given in Figure 2.1. The material data is also given below. Triangular elements with 3 nodes and the hypothesis of plane stress are used in the analysis.

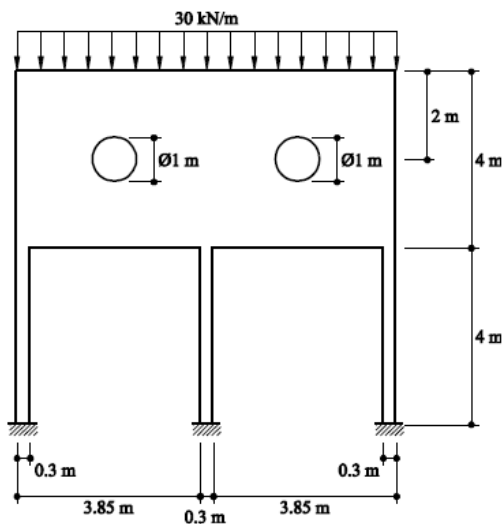

Material

$$E = 3.0 \times 10^{10} Pa$$

$$\nu = 0.2$$

$$thickness = 0.20m \text{ (plate and columns)}$$

Figure 2.1: Plate with two sections

2.2 Stress distribution

The intact case where there is no displacement in the central column and the case with the displacement $\delta = 0.10m$ in the central column were analyzed. The distribution of stresses σ_x , σ_y and τ_{xy} from both cases are compared side by side in Figure 2.2 to Figure 2.4.

It can be seen that stress distribution is significantly different in the y-direction as shown in Figure 2.3. The high stress σ_y is distributed in the concrete plate for the intact case while the high stress σ_y is concentrated in the central column for the case with displacement. Note that the maximum stress values are much higher in the case with the displacement.

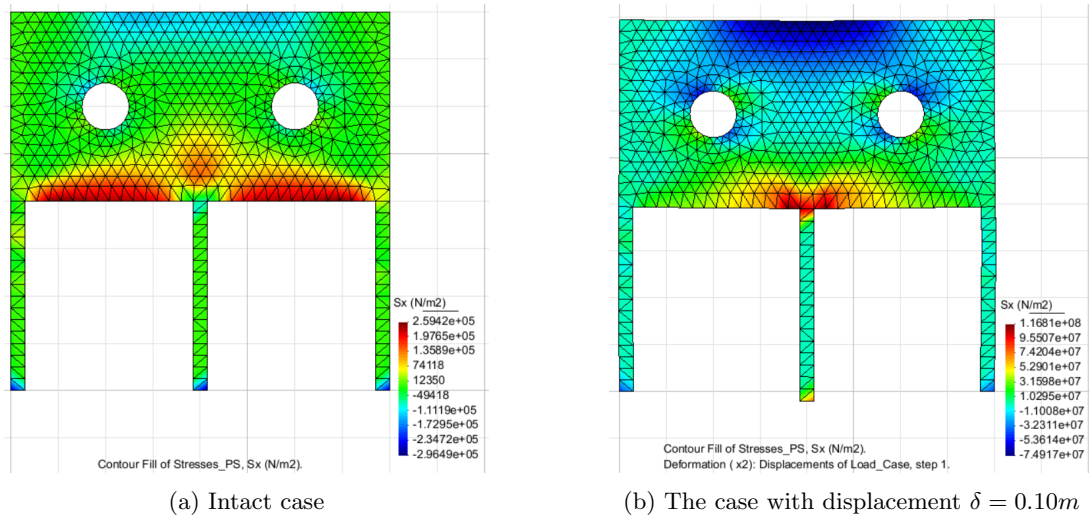

Figure 2.2: The distribution of stress σ_x

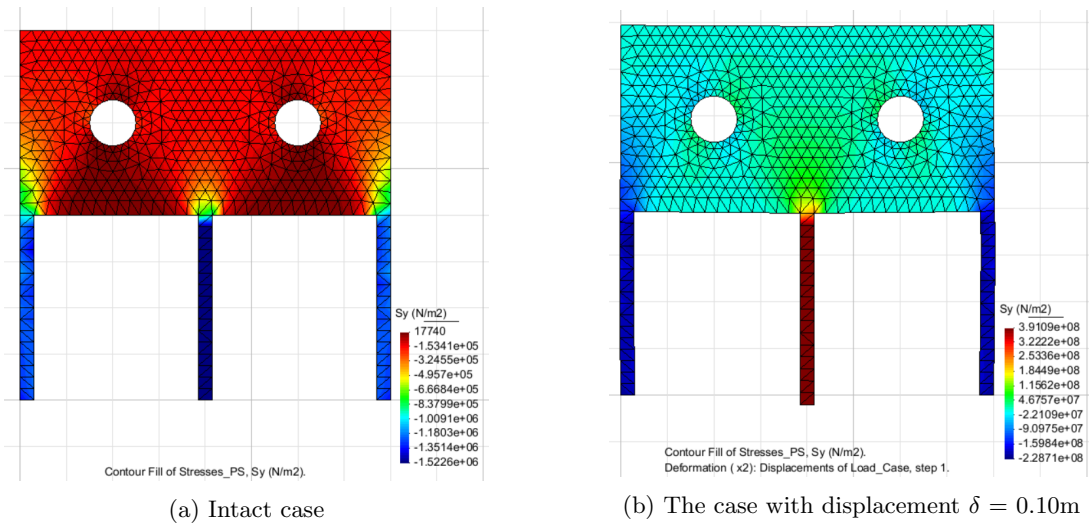

Figure 2.3: The distribution of stress σ_y

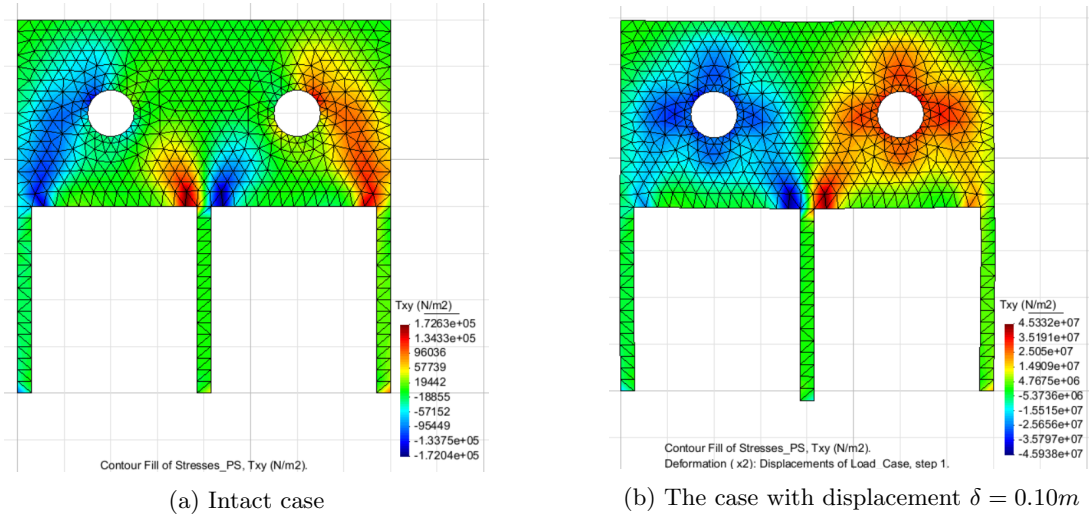
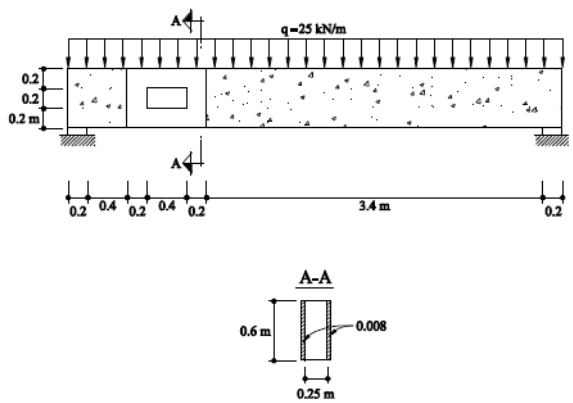

Figure 2.4: The distribution of stress τ_{xy}

3 Exercise 3: Plate with ventilation hole

3.1 Introduction

Figure 3.1 represents a reinforced concrete plate with simple supports. The plate possesses a hole for a ventilation pipe, and due to that, a metal reinforcement sheet is placed on both sides of the plate in the area of the hole. The dimensions of the structure as well as the material parameter for concrete and steel are given below. Assume the plane stress hypothesis. Analyze the state of stress in the concrete plate and the metal reinforcement sheets with 4-nodes quadrilateral elements.



Data:

$$\text{Concrete} \quad \begin{cases} E = 3 \times 10^{10} \text{ N/m}^2 \\ \nu = 0.2 \\ \text{thickness} = 0.25 \text{ m} \end{cases}$$

$$\text{Steel} \quad \begin{cases} E = 2.1 \times 10^{11} \text{ N/m}^2 \\ \nu = 0.3 \\ \text{thickness} = 0.016 \text{ m} \end{cases}$$

Figure 3.1: Plate with ventilation hole

3.2 Stress distribution

In Figure 3.2 to Figure 3.4, the results of stress distribution in the plate are presented, along with the stress distribution in each material (i.e. the concrete plate and the metal sheets) shown separately.

It can be seen in Figure 3.2 and Figure 3.3 that the concrete plate sustains mostly the compression stress. While on the ventilation opening, where the stress concentration and tension stress occur at the bottom of the plate and at the opening edges, the stress is distributed to the metal sheets as metal is stiffer and behaves much better in tension compared to concrete. The similar situation can be also observed for shear stress τ_{xy} . In Figure 3.4, the metal sheets withhold most of the shear stress.

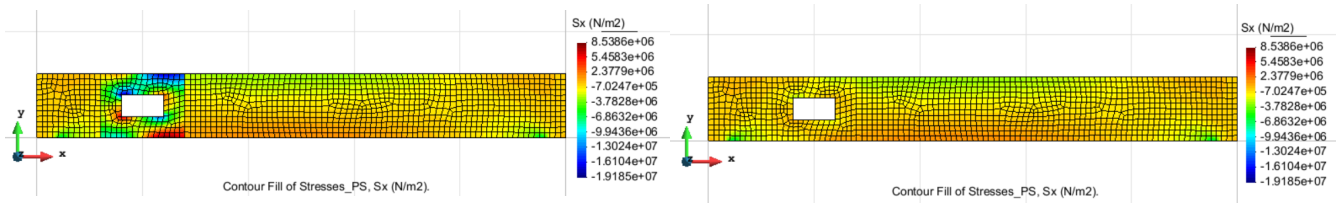

(a) The σ_x distribution in the plate

(b) The σ_x distribution in the concrete plate

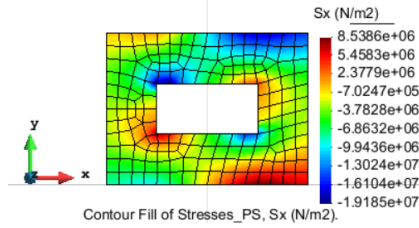

(c) The σ_x distribution the metal sheet

Figure 3.2: The σ_x distribution

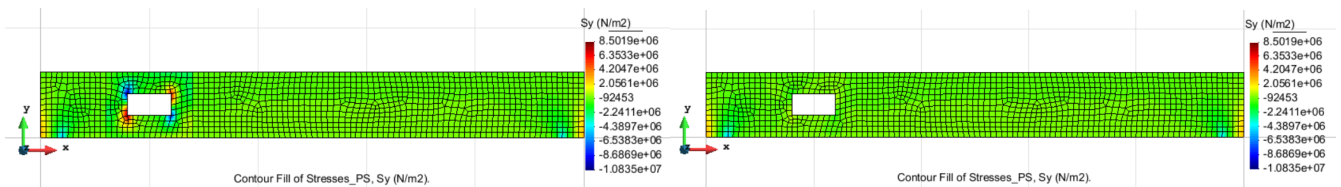

(a) The σ_y distribution in the plate

(b) The σ_y distribution in the concrete plate

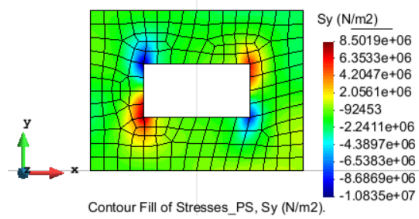

(c) The σ_y distribution in the metal sheet

Figure 3.3: The σ_y distribution

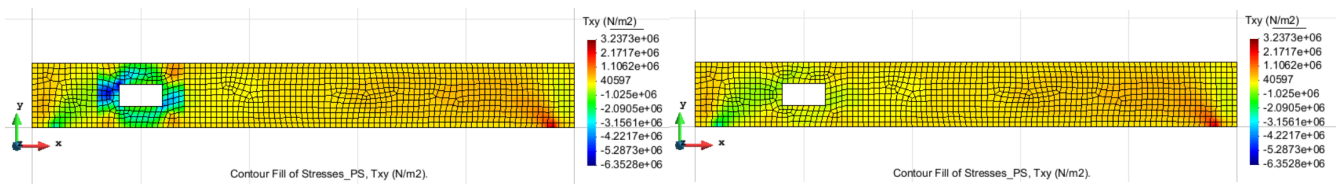

(a) The τ_{xy} distribution in the plate

(b) The τ_{xy} distribution in the concrete plate

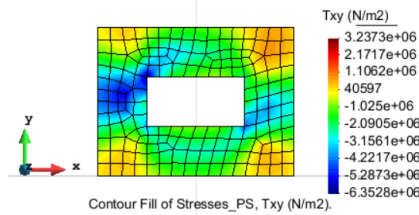

(c) The τ_{xy} distribution in the metal sheet

Figure 3.4: The τ_{xy} distribution

4 Exercise 4: Prismatic water tank

4.1 Introduction

The structure in Figure 4.1 represents the cross-section of the wall of a rectangular water tank made of reinforced concrete. The hypothesis of planar deformation and quadrilateral elements with 4 nodes are used in the analysis.

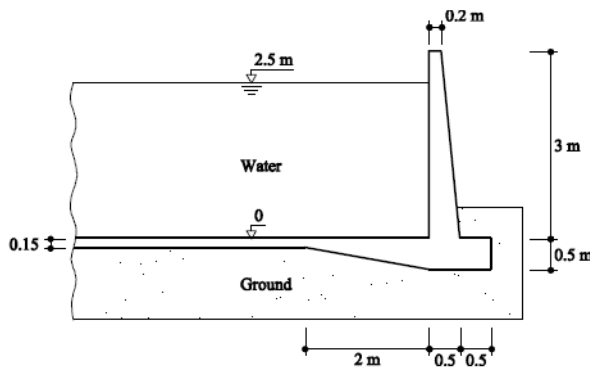

Data:

$$\text{Concrete} \begin{cases} E = 3 \times 10^{10} \text{ N/m}^2 \\ \nu = 0.2 \\ \gamma = 24000 \text{ m/cm}^3 \end{cases}$$

$$\text{Ground} \begin{cases} \text{Load Coefficient} = 50 \text{ N/cm}^3 \end{cases}$$

Figure 4.1: Prismatic water tank

4.2 Displacement distribution

Figure 4.2 illustrates the deformed water tank. As the ground is treated as an elastic spring instead of the fixed support, under the water self-weight, the structure moved downward. In addition, the water exerts as a linear horizontal load on the side wall of the tank, which caused the side wall to bend and rotate with respect to the point where the thickness of the horizontal plate changes. It can be seen as a plastic hinge is developed at that point and the right side of the structure is rotating with respect to it.

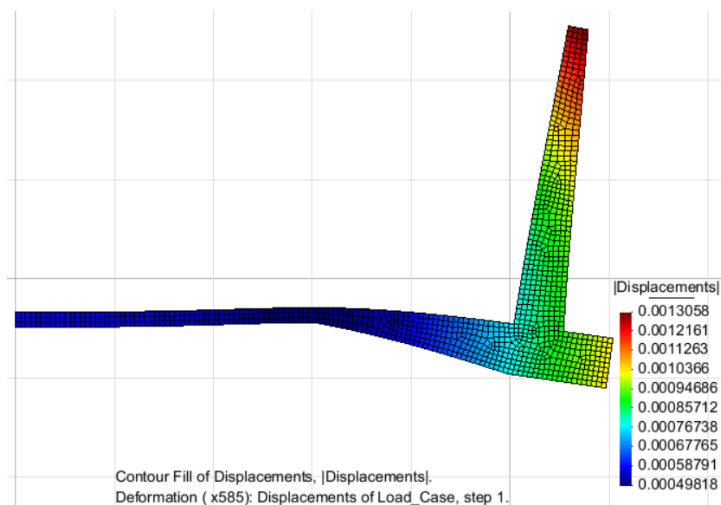

Figure 4.2: The deformed water tank

4.3 Stress distribution

The distribution of the normal and shear stresses are shown in Figure 4.3. From the first three diagrams (Figure 4.3a, 4.3b, 4.3c), it is easy to observe that the upper side of the horizontal plate and the inner side wall sustain tension while the bottom side of the horizontal wall as well as the outside side wall is undertaking compression, which fits the behavior of the structure. In Figure 4.3d, the maximum shear stress occurs at the connection of horizontal plate and the vertical side wall. Just as explained before that the structure is rotating with respect to that point that caused the concentration of shear stress.

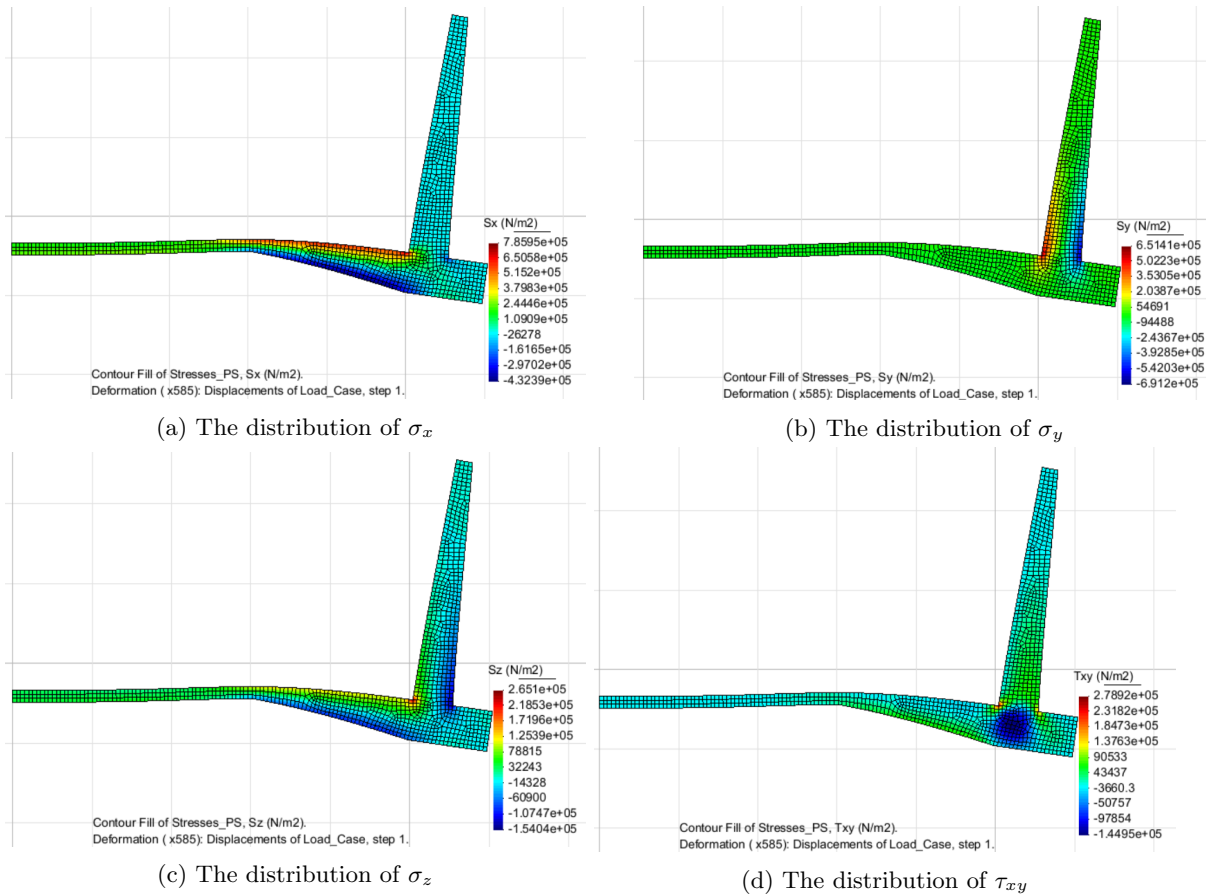

Figure 4.3: Stress distribution in the cross-section of the tank

Appendices

A Exercise 1: Thin plate under dead weight

Additional displacement and stress contours in the y-direction when using quadrature elements are shown here.

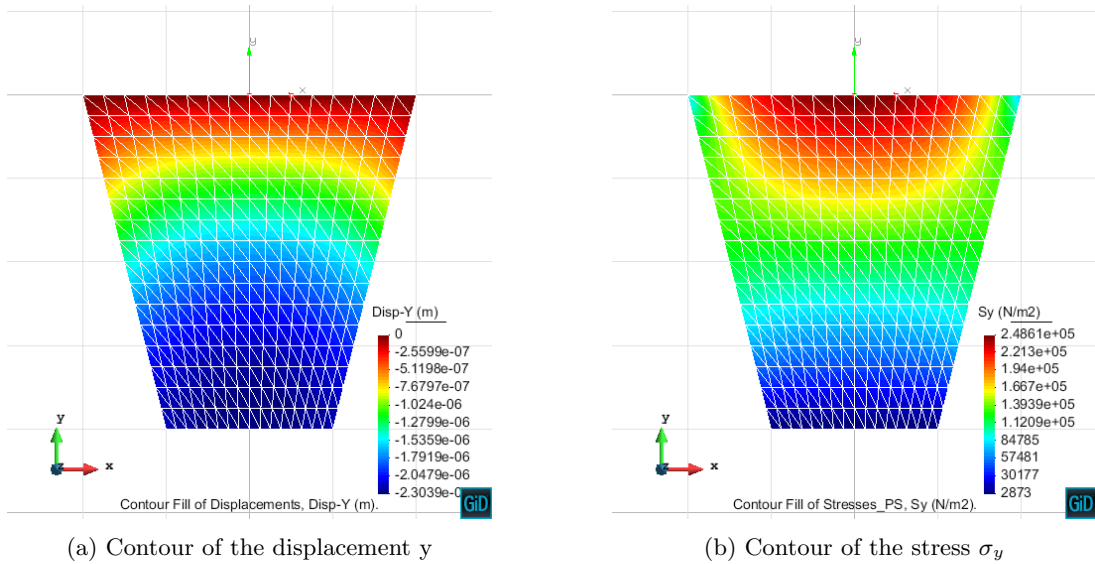

Figure A.1: Results when using triangular elements with 6 nodes

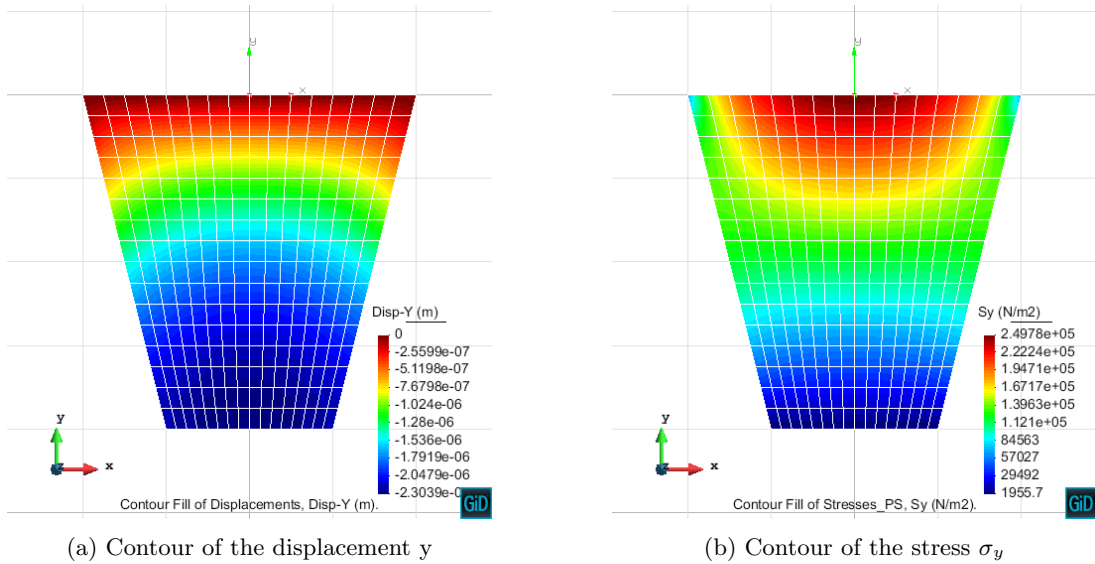
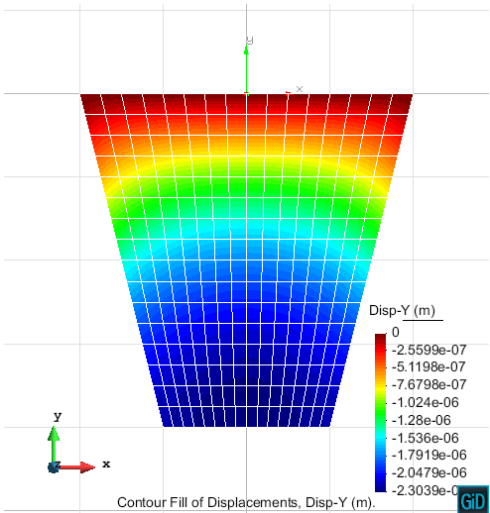
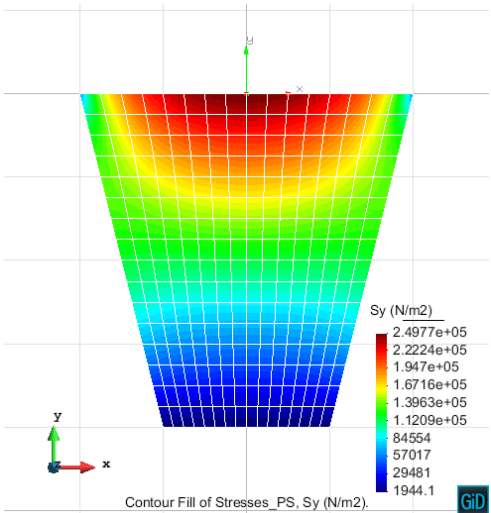

Figure A.2: Results when using quadrilateral elements with 8 nodes



(a) Contour of the displacement y



(b) Contour of the stress σ_y

Figure A.3: Results when using quadrilateral elements with 9 nodes