



UNIVERSITAT POLITÈCNICA
DE CATALUNYA
BARCELONATECH



Erasmus
Mundus

UNIVERSITAT POLITÈCNICA DE CATALUNYA, BARCELONA

MSC. COMPUTATIONAL MECHANICS ERASMUS MUNDUS

GID ASSIGNMENT 1

Computational Structural Mechanics & Dynamics

Author:

Nikhil Dave

Date: March 16, 2018

Exercise 1: Thin plate under dead weight

Analyse the thin plate shown in the figure, which is submitted to its self weight. Compare the obtained results with the solution that is obtained when refining the mesh. Use triangular elements with 3 and 6 nodes and quadrilaterals with 4, 8 and 9 nodes.

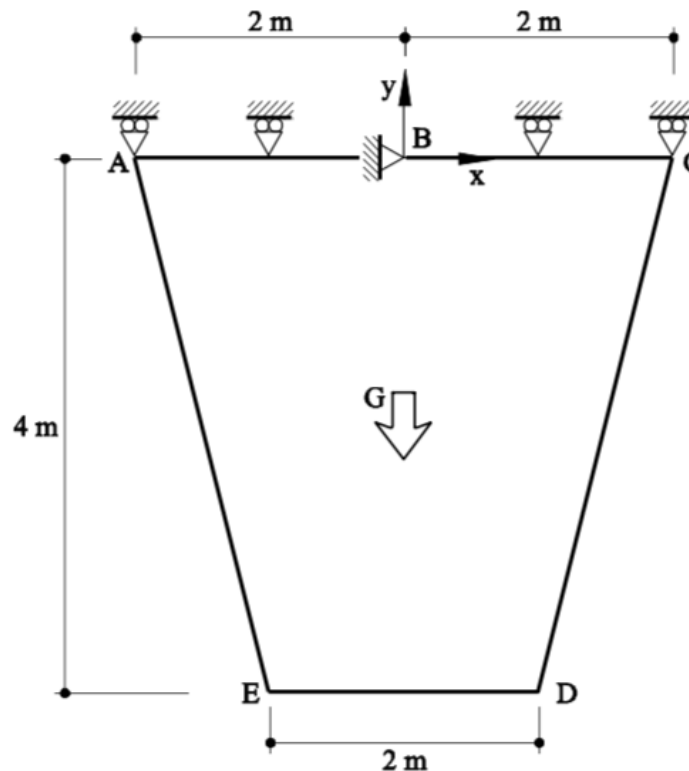

Figure 1: Thin plate under dead weight

Solution:

1.1. Purpose of the example

The objective of this exercise is to compare the FEM solution obtained by using triangular and quadrilateral elements in a thin plate model deforming under dead weight (shown in Figure 1) and study their rate of convergence. The complete analysis process is divided into pre-processing, processing and post-processing in the following sections. This is followed by comparison of the results obtained with different meshes with the given sought solution.

1.2. Analysis

1.2.1 Pre-processing

(i) Geometry

The first step of pre-processing is to model the geometry of the thin plate as per the given dimensions in GiD as shown in Figure 2.

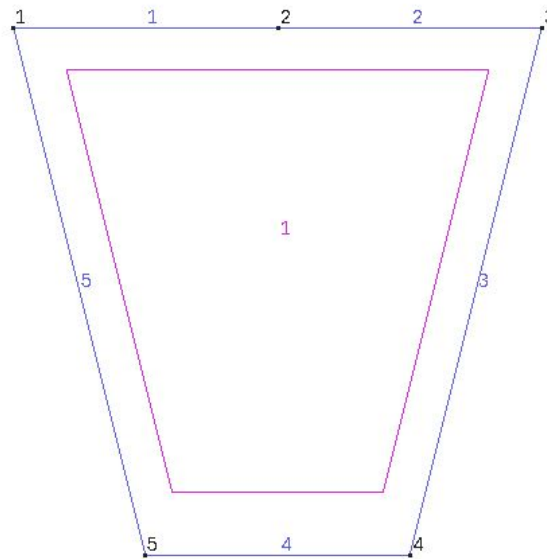

Figure 2: Defining the geometry

(ii) Data

Once the geometry is defined, we apply the given data to the model.

Problem type

Since, the given plate is thin, we select the plane state problem type from the Ram-series Educational 2D module.

Boundary Conditions

Next, we define the boundary conditions for the problem as shown in Figure 3. For the given problem, the edge AC is restricted in the y -direction and point B is restricted in the x -direction. Since the structure is submitted to its self weight only, there are no external loads defined in this problem.

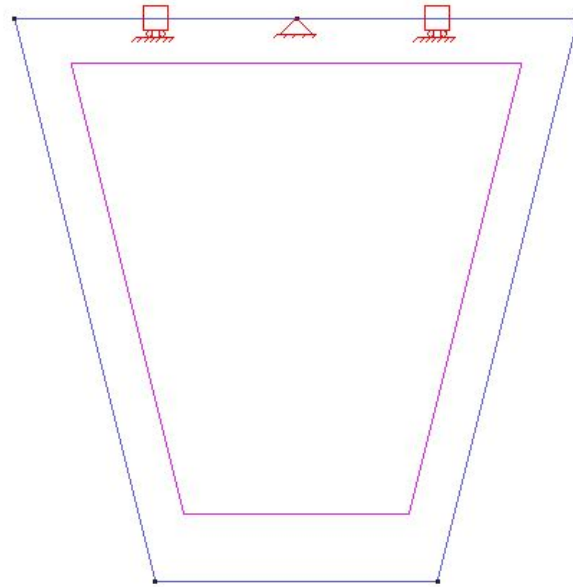

Figure 3: Boundary conditions

Material

The material properties of the structure is defined with the given parameters shown in Figure 4.

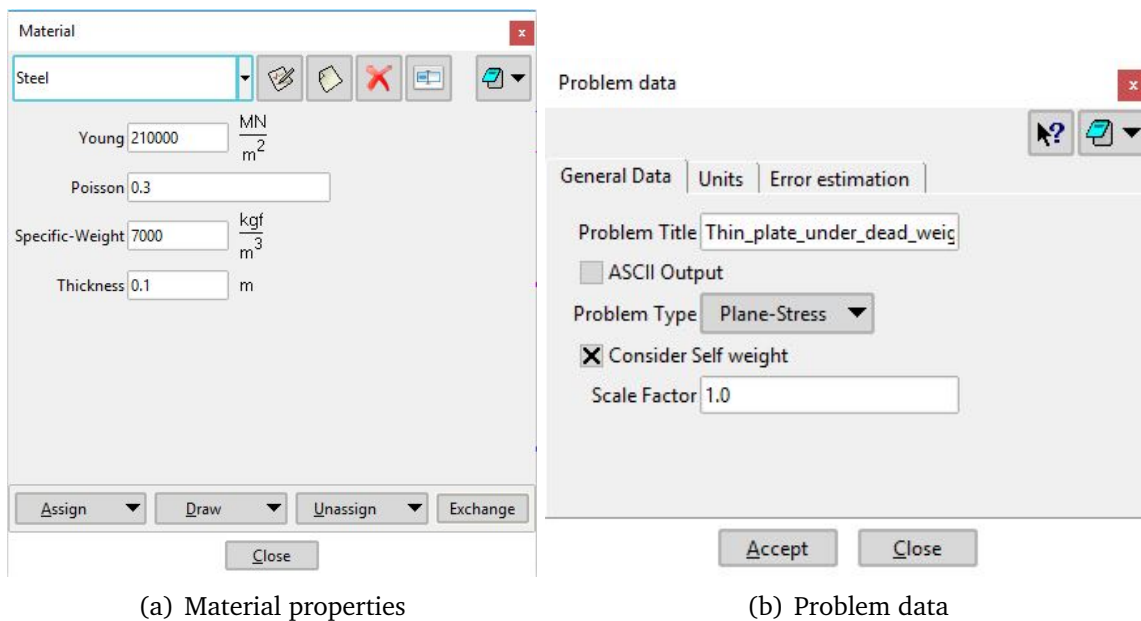

Figure 4: Material properties and problem data defined

Problem Data

The definition of problem data is an important step for the analysis where the options like title, type of problem and the result units are to be selected. It is important to note here that, as given in the problem, the self weight is considered in this problem with a scale factor of 1.0. Figure 4 shows the necessary data used for this problem.

Mesh

In this problem, a structured mesh is used with triangular and quadrilateral elements. Basically, 5 type of elements based on the type and order are analysed for this problem as,

- Triangular elements with linear shape functions (3 nodes)
- Triangular elements with quadratic shape functions (6 nodes)
- Quadrilateral elements with linear shape functions (4 nodes)
- Quadrilateral elements with quadratic shape functions (8 nodes)
- Quadrilateral elements with quadratic shape functions (9 nodes)

Figure 5 shows the structured mesh used for linear triangular and quadrilateral elements and different mesh elements types used for this analysis are shown in Figure 6.

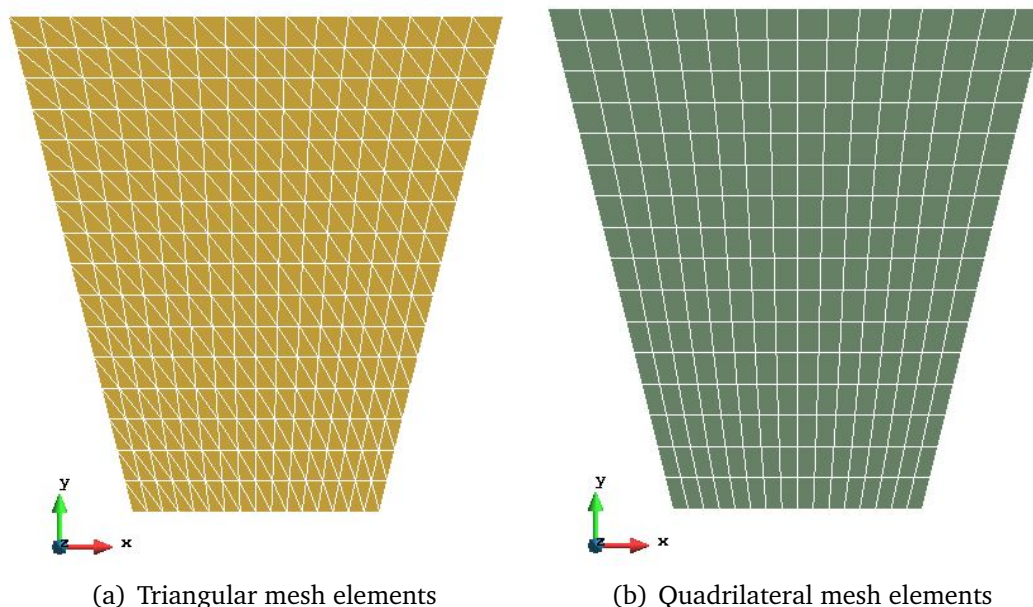
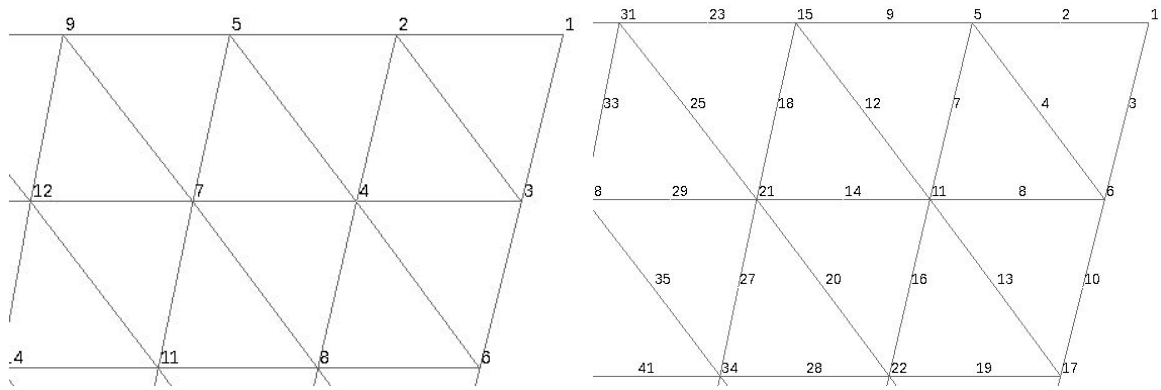
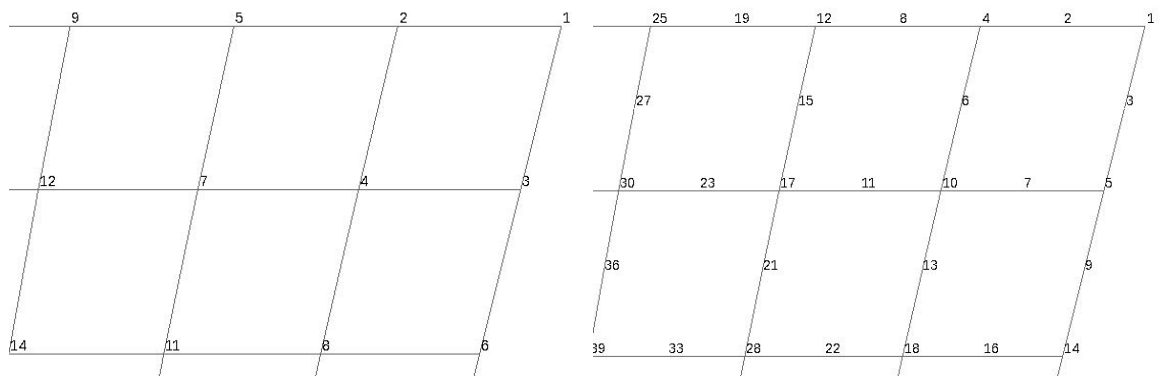

Figure 5: Structured mesh generation



(a) Triangular elements with 3 nodes

(b) Triangular elements with 6 nodes



(c) Quadrilateral elements with 4 nodes

(d) Quadrilateral elements with 8 nodes

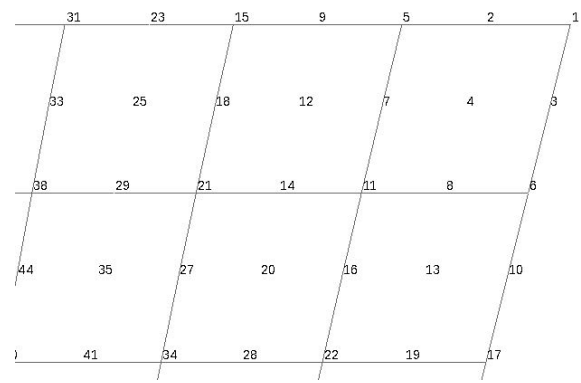

(e) Quadrilateral elements with 9 nodes

Figure 6: Different mesh element types used in the analysis

1.2.2 Processing

In this section, we calculate the solution of the problem for different meshes generated.

1.2.3 Post-processing

The results obtained for the different meshes generated in this problem are shown below:

TRIANGULAR ELEMENTS WITH 3 NODES

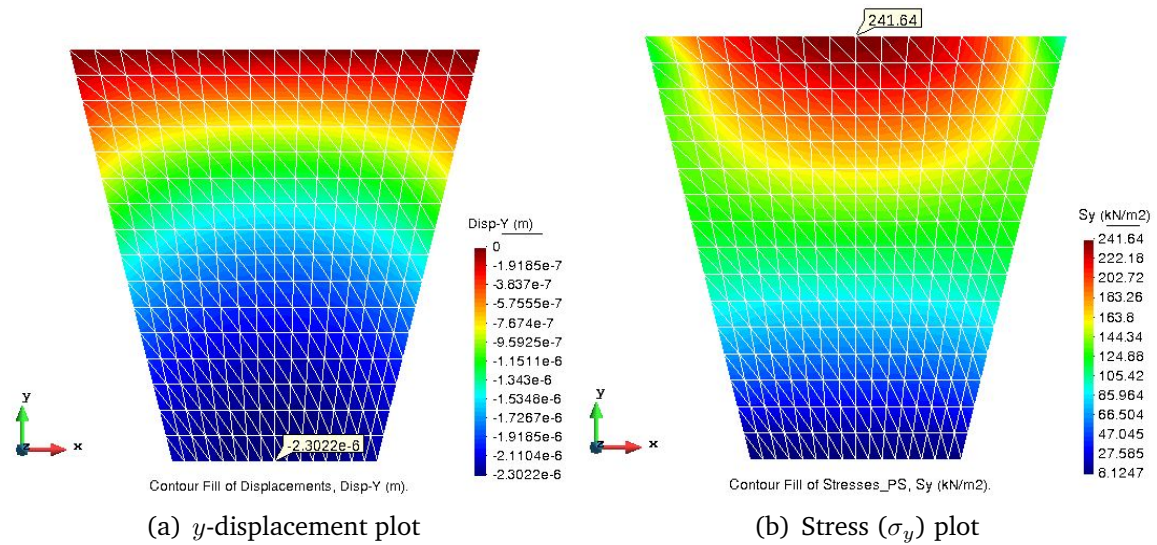

Figure 7: Results: Triangular elements with 3 nodes

TRIANGULAR ELEMENTS WITH 6 NODES

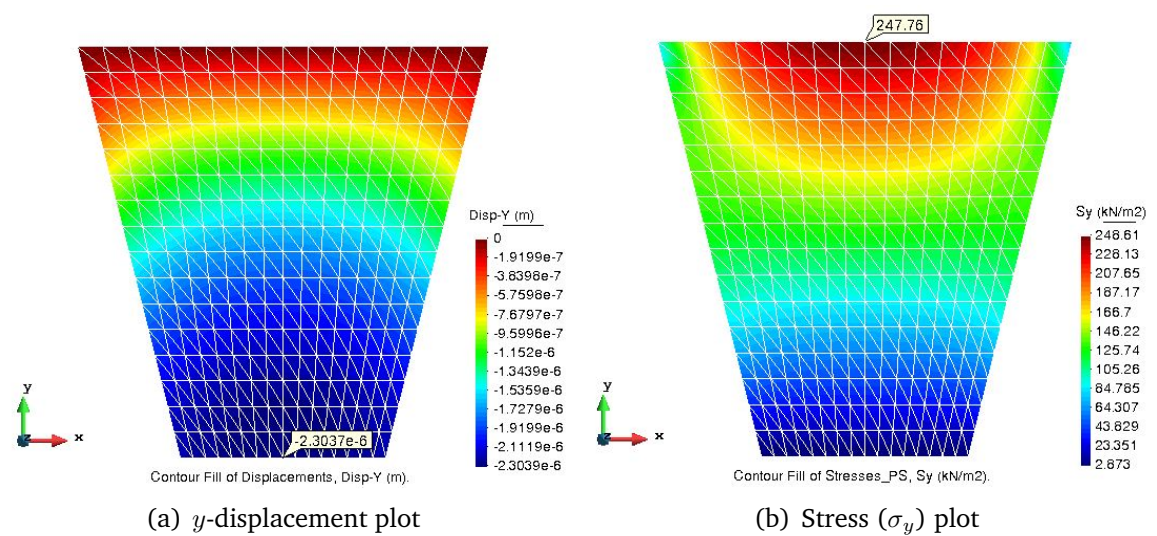

Figure 8: Results: Triangular elements with 6 nodes

QUADRILATERAL ELEMENTS WITH 4 NODES

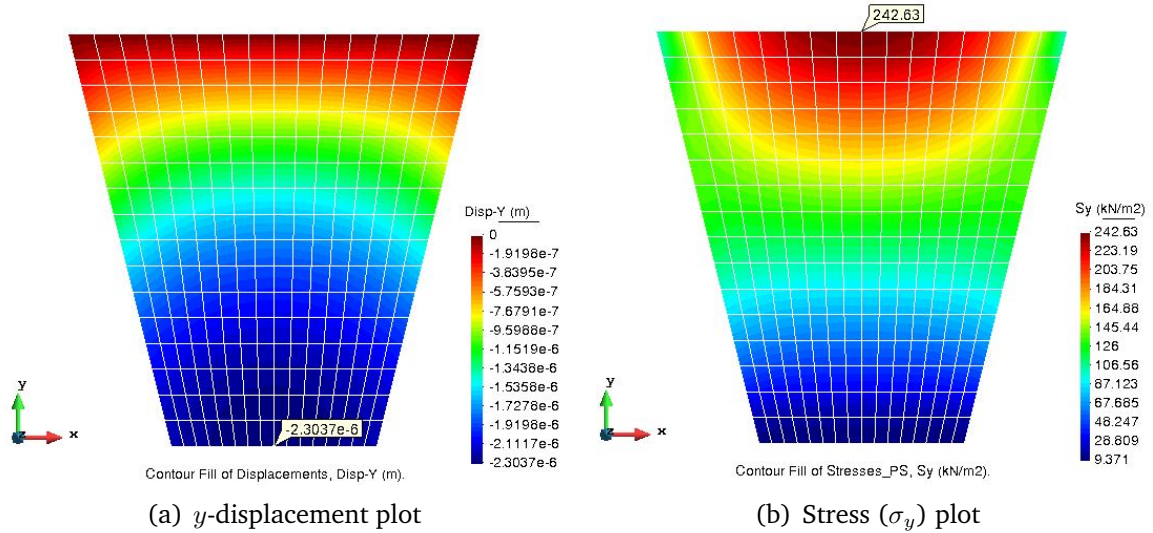

Figure 9: Results: Quadrilateral elements with 4 nodes

QUADRILATERAL ELEMENTS WITH 8 NODES

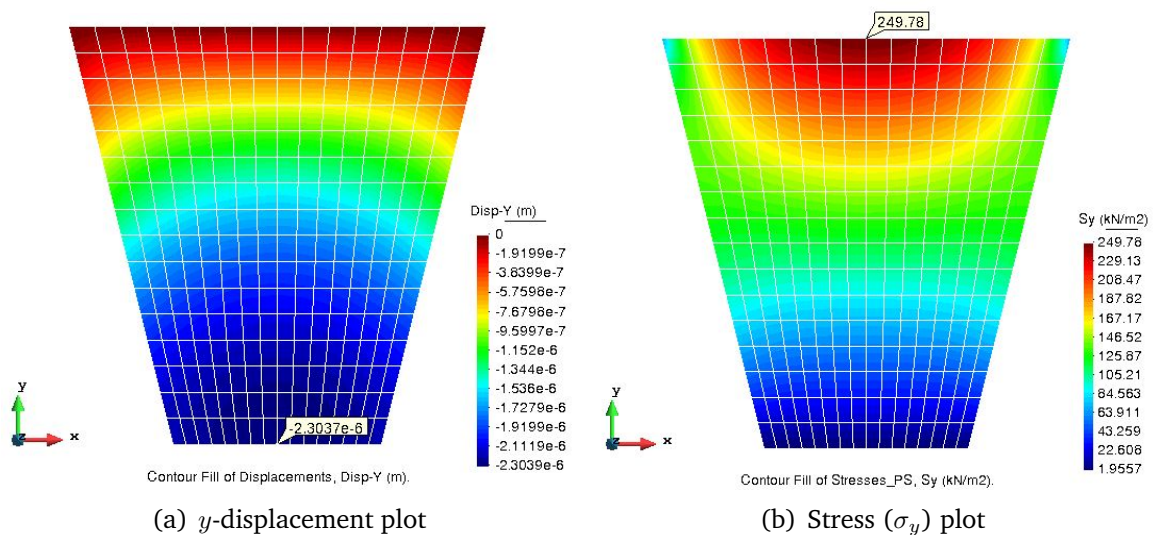

Figure 10: Results: Quadrilateral elements with 8 nodes

QUADRILATERAL ELEMENTS WITH 9 NODES

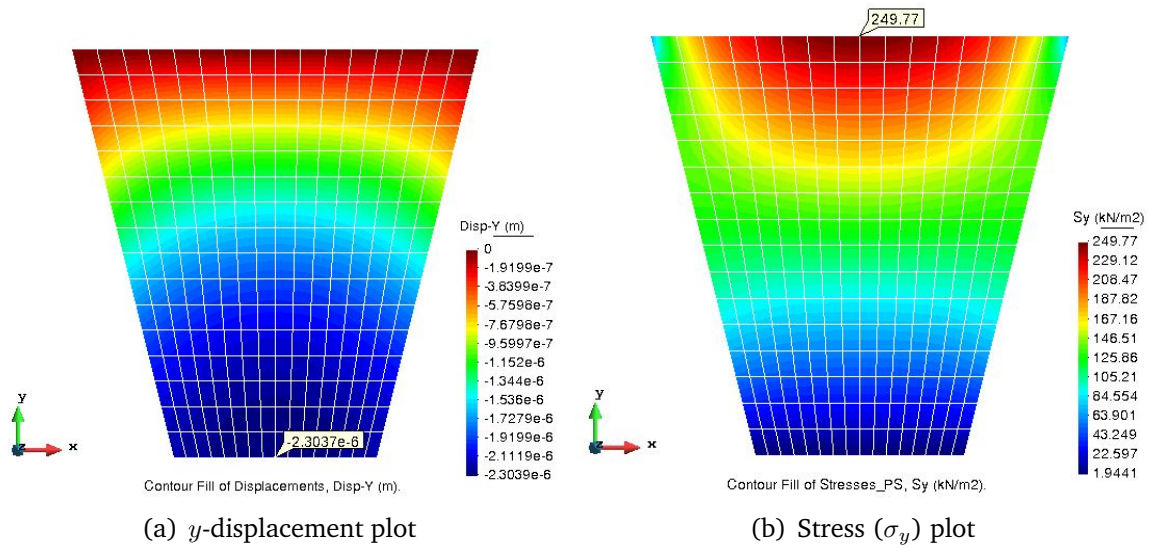

Figure 11: Results: Quadrilateral elements with 9 nodes

1.3. Comparison of the results

The results of the analysis obtained with different element types are compared in Table 1.

Element type	Number of elements	Degrees of freedom	Stress σ_y at B [MN/m^2]	Displacement y at centre of side ED [m]	ϵ_{Displ_y} %	ϵ_{σ_y} %
Tria with 3 nodes	512	289	241.64	2.3022e -6	2.17	-1.87
Tria with 6 nodes	512	1089	243.76	2.3027e -6	1.31	-1.89
Quad with 4 nodes	256	289	242.63	2.3037e -6	1.77	-1.93
Quad with 8 nodes	256	833	249.78	2.3017e -6	-1.13	-1.85
Quad with 9 nodes	256	1089	249.77	2.3007e -6	-1.12	-1.80

Table 1: Comparison table for results obtained with different mesh element types

The sought solution given for this problem is:

Displacement y at centre of side ED = $2.26e - 6 \text{ m}$

Stress σ_y at point B = $0.247 \frac{MN}{m^2}$

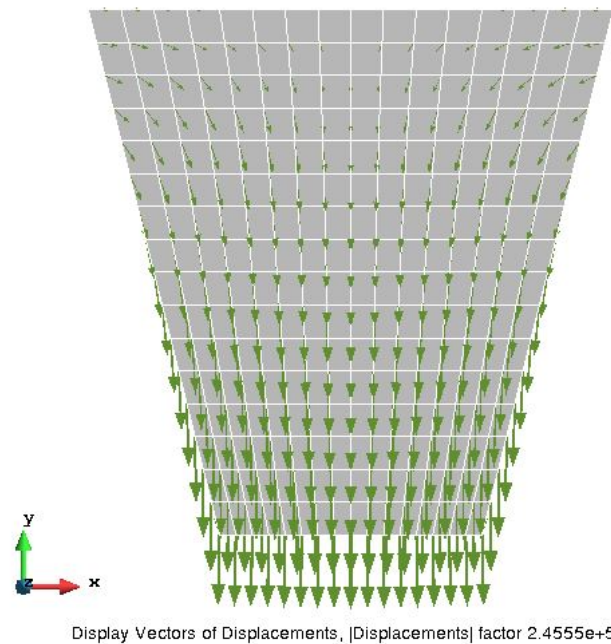

Figure 12: Displacement vectors: continuous increase in the negative y -direction

As expected, the effect of the constraint at point B is seen by its high stress values, which is the evidently maximum in the whole structure. The effect of the dead weight condition imposed on the structure can also be seen by the continuous increment in the displacement values as we move towards the bottom of the structure as shown by the vector plot in Figure 12. It can also be inferred from the results in Table 1 that the quadrilateral elements perform better than the triangular elements. For instance, with same degrees of freedom (dofs), the results obtained with linear quadrilateral are more accurate than the linear triangles. In fact, it can also be seen that with lesser degrees of freedom using a 8 noded quad, the results are better than quadratic triangular elements with higher dofs.

With subsequent mesh refinement, we also observed that the quadratic elements converge faster than the linear elements. The linear triangular elements have the least convergence speed and require a finer mesh to attain convergence with the provided sought solution whereas the quadrilateral elements with 9 nodes has the fastest convergence. The meshes shown in figures 7-11 show a high level of precision due to the simplicity of the problem which is just under the dead weight of the structure.

Exercise 2: Plate with two sections

The structure in the figure presents a reinforced concrete plate with two holes, supported by three columns. The central column undergoes a displacement δ due to sag of the foundation caused by a leakage in some pipes nearby. Analyse the distribution of the stresses that the drop of the central column produces. Assume the hypothesis of plane stress. Use triangular elements with 3 nodes for the analysis.

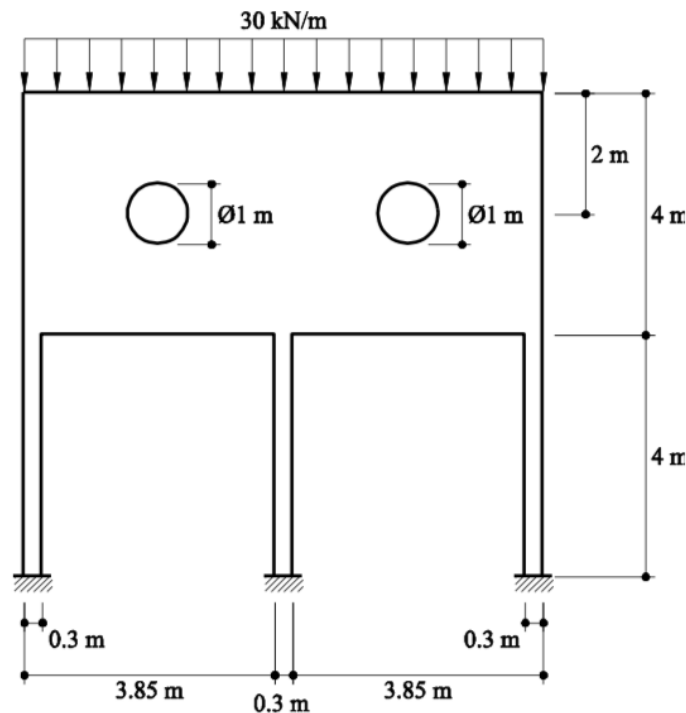

Figure 13: Plate with two sections

Solution:

2.1. Purpose of the example

The objective of this exercise is to analyse the deformation and distribution of stresses which a drop of the central column produces on a reinforced concrete plate with two holes, supported by three columns.

2.2. Analysis

2.2.1 Pre-processing

(i) Geometry

The first step of pre-processing is to model the geometry of the concrete plate as per the given dimensions in GiD as shown in Figure 14.

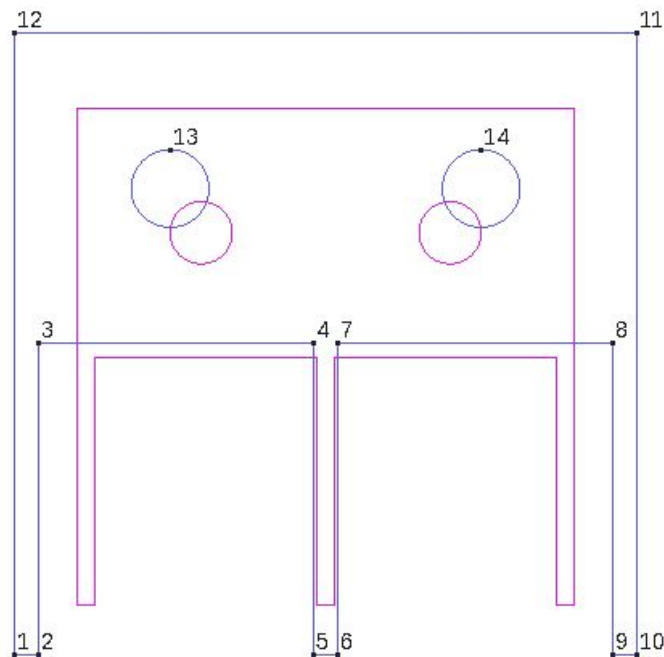

Figure 14: Defining the geometry

(ii) Data

Once the geometry is defined, we apply the given data to the model.

Problem type

Since, the given plate is thin (0.2 m), we assume it as a plane stress problem and select the plane state problem type from the Ramseries Educational 2D module.

Boundary Conditions

Next, we define the boundary conditions for the problem as shown in Figure 15. For the given problem, the three pillars supporting the structure are fixed in both the directions. Since the central column undergoes a displacement δ due to sag of the foundation, we do not have a fixed value for the y -displacement. Therefore we perform various cases with different values of δ to study the distribution of stresses. A distributed force of 30 kN/m acts on top of the structure as given in the problem.

Material

The material properties of the structure is defined with the given parameters shown in Figure 16.

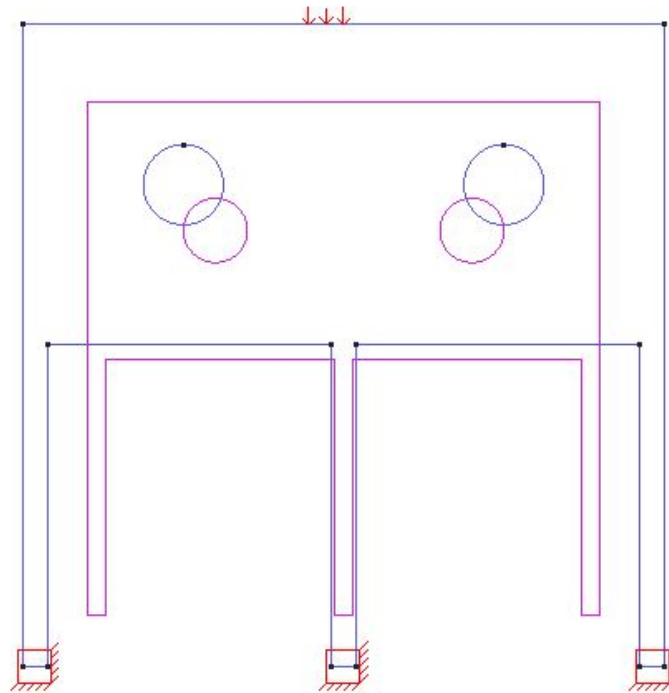

Figure 15: Boundary conditions

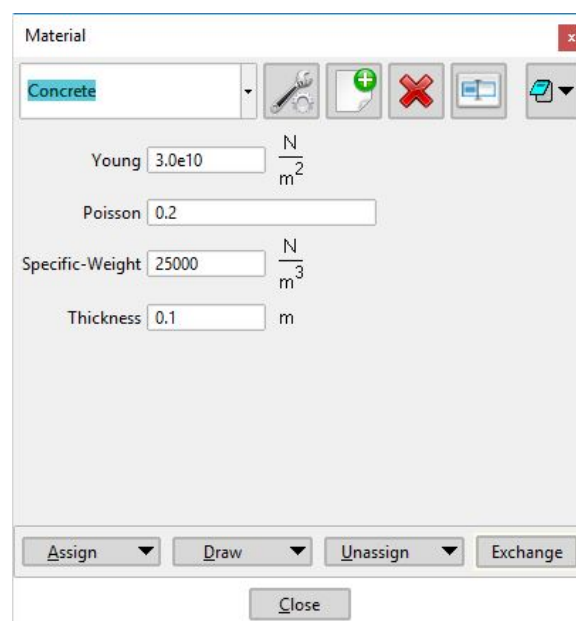

Figure 16: Material properties

Problem Data

In the problem data definition, we consider the self weight of the plate with a scale factor of 1.0. Figure 17 shown the necessary data used for this problem.

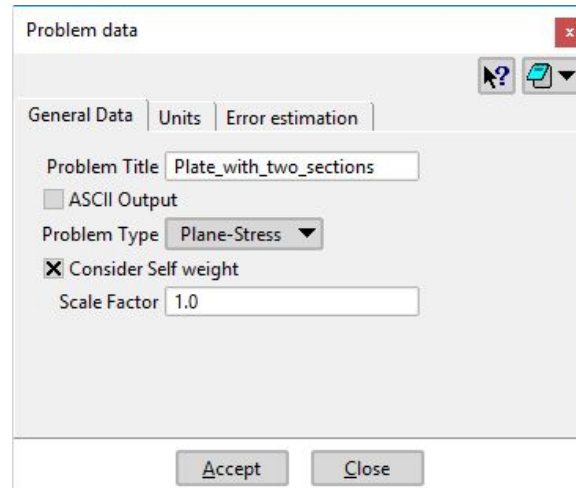

Figure 17: Problem data

Mesh

In this problem, a structured mesh is generated with linear triangular elements. Figure 18 shows the structured mesh used with 3 noded triangular elements.

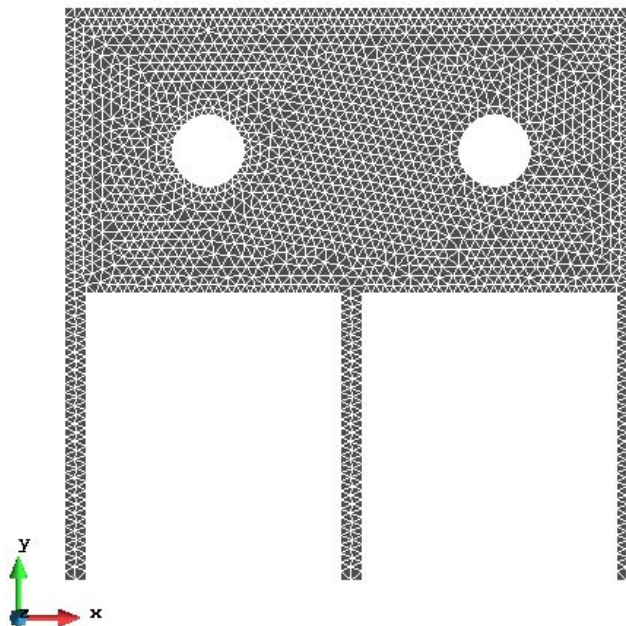

Figure 18: Structured mesh generation

2.2.2 Processing

In this section, we calculate the solution of the problem for different values of the y -displacement δ . Four different cases are analysed with $\delta = 0$, $\delta = 0.001\text{ m}$, $\delta = 0.01\text{ m}$ and $\delta = 0.1\text{ m}$. These cases would give us a relationship in the results obtained with only considering self weight and with increasing displacement values.

2.2.3 Post-processing

The results obtained for the deformation of the structure with different values of δ are shown below:

Case 1: $\delta = 0$

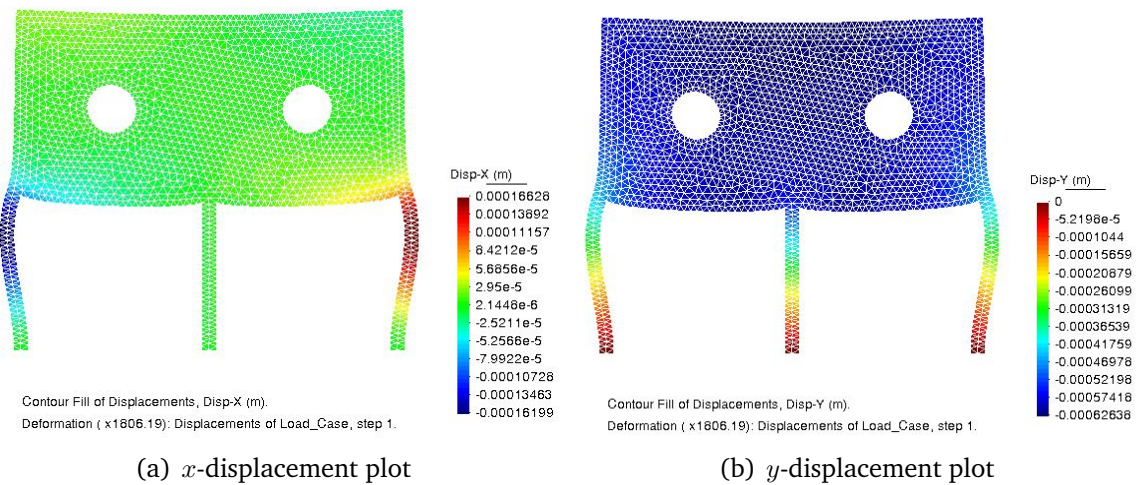

Figure 19: Results: Deformation plot in the structure with $\delta = 0$

Case 2: $\delta = 0.001\text{ m}$

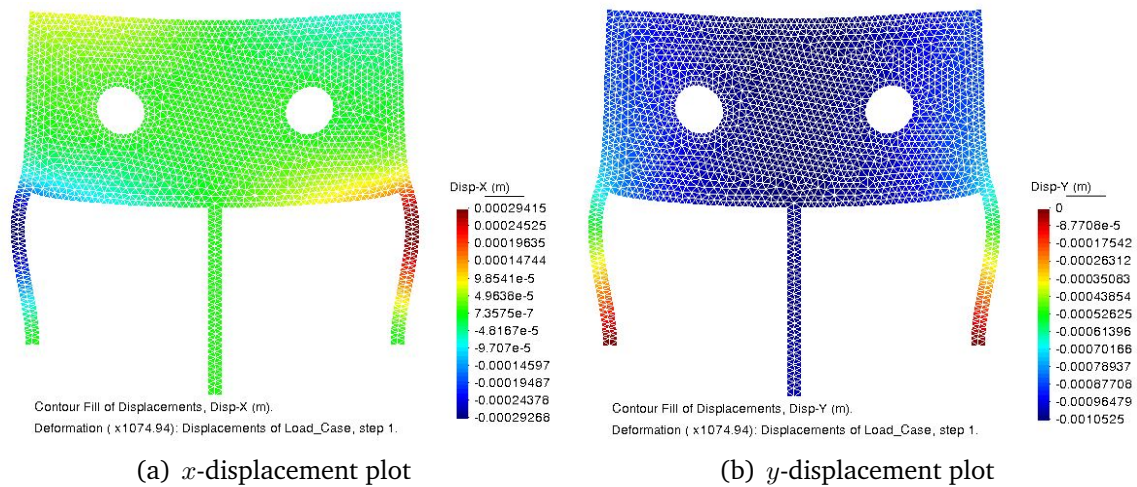

Figure 20: Results: Deformation plot in the structure with $\delta = 0.001\text{ m}$

Case 3: $\delta = 0.01\ m$

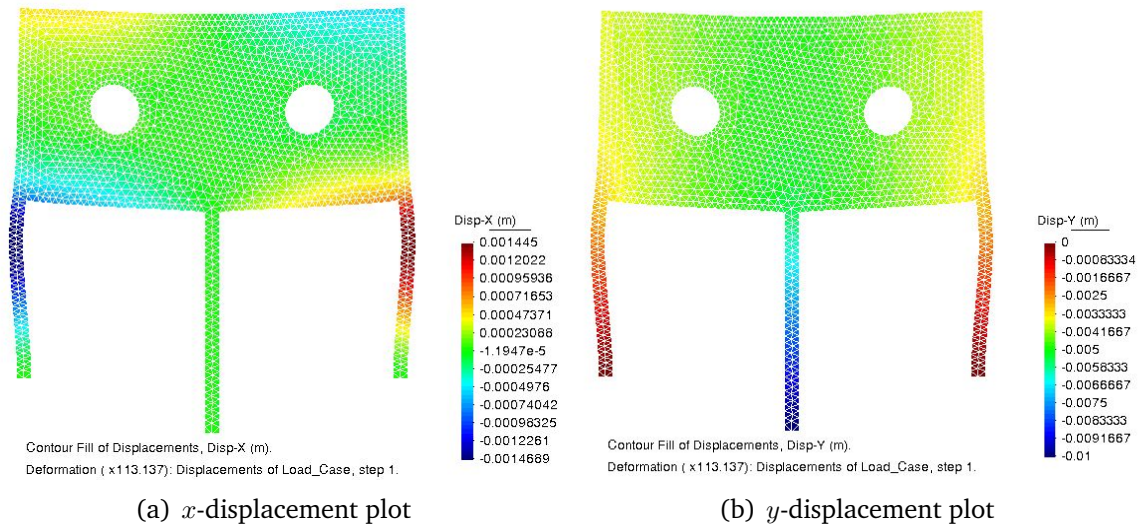

Figure 21: Results: Deformation plot in the structure with $\delta = 0.01\ m$

Case 4: $\delta = 0.1\ m$

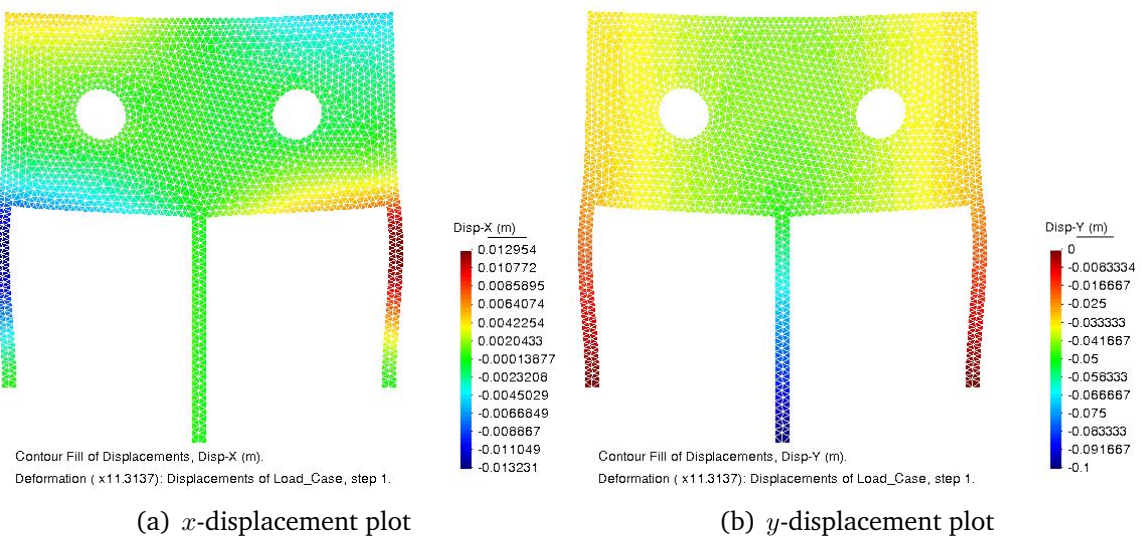

Figure 22: Results: Deformation plot in the structure with $\delta = 0.1\ m$

Next, the results obtained for the stress distribution in the structure with different values of δ are shown:

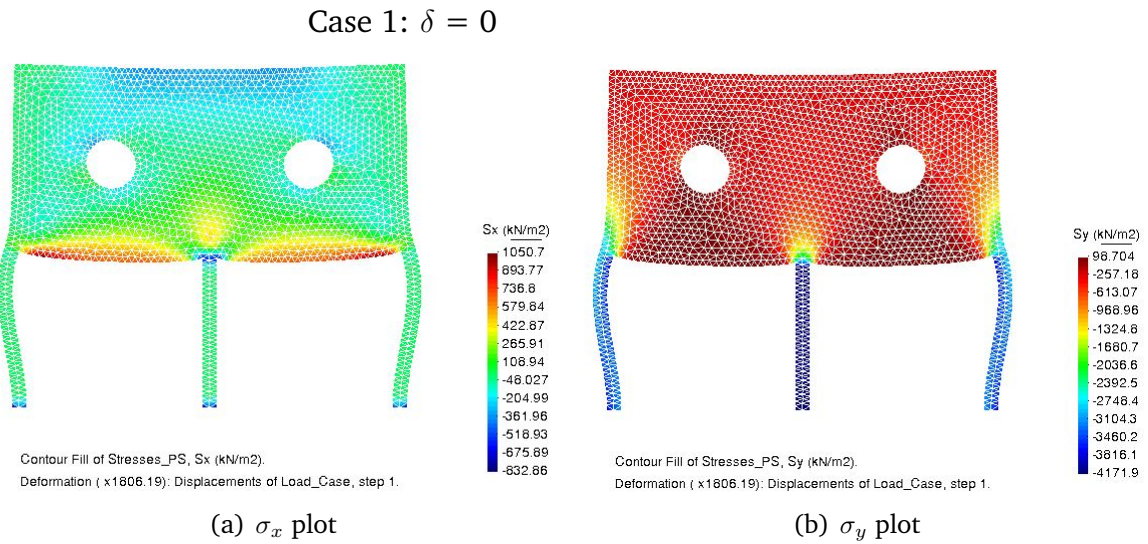

Figure 23: Results: Stress distribution plot in the structure with $\delta = 0$

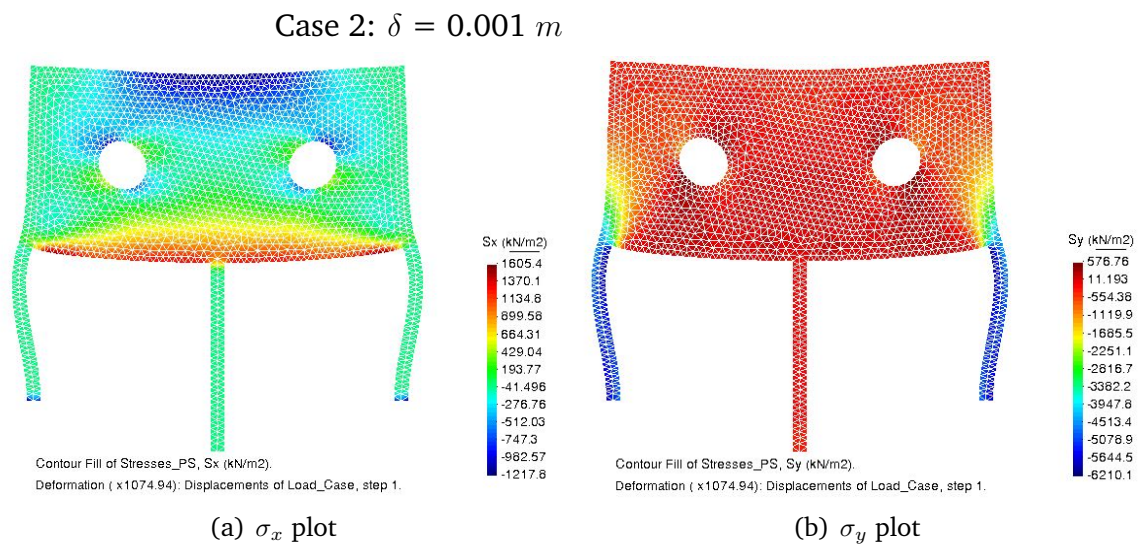

Figure 24: Results: Stress distribution plot in the structure with $\delta = 0.001 \text{ m}$

Case 3: $\delta = 0.01\ m$

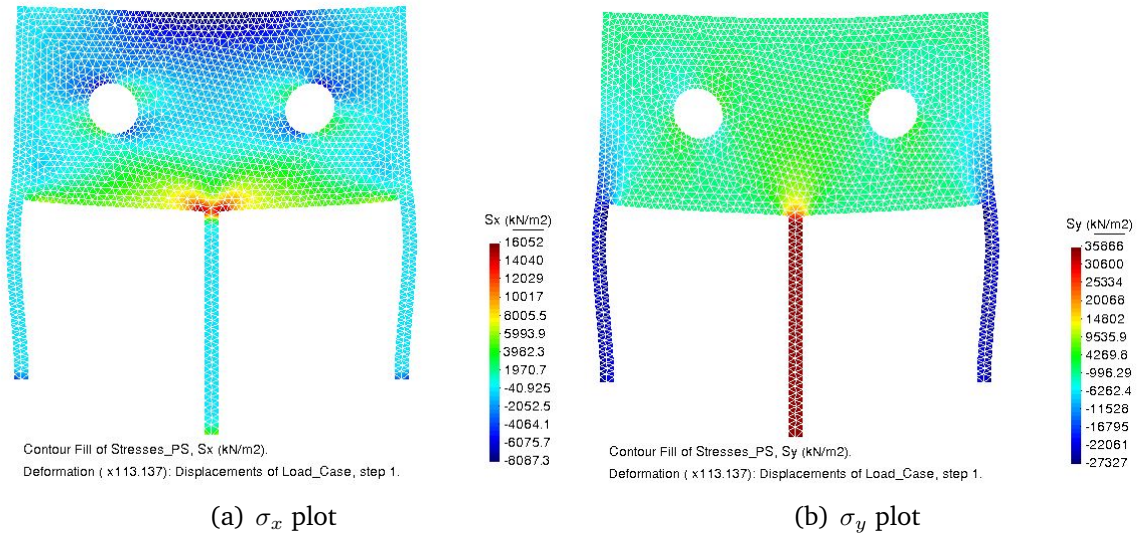

Figure 25: Results: Stress distribution plot in the structure with $\delta = 0.01\ m$

Case 4: $\delta = 0.1\ m$

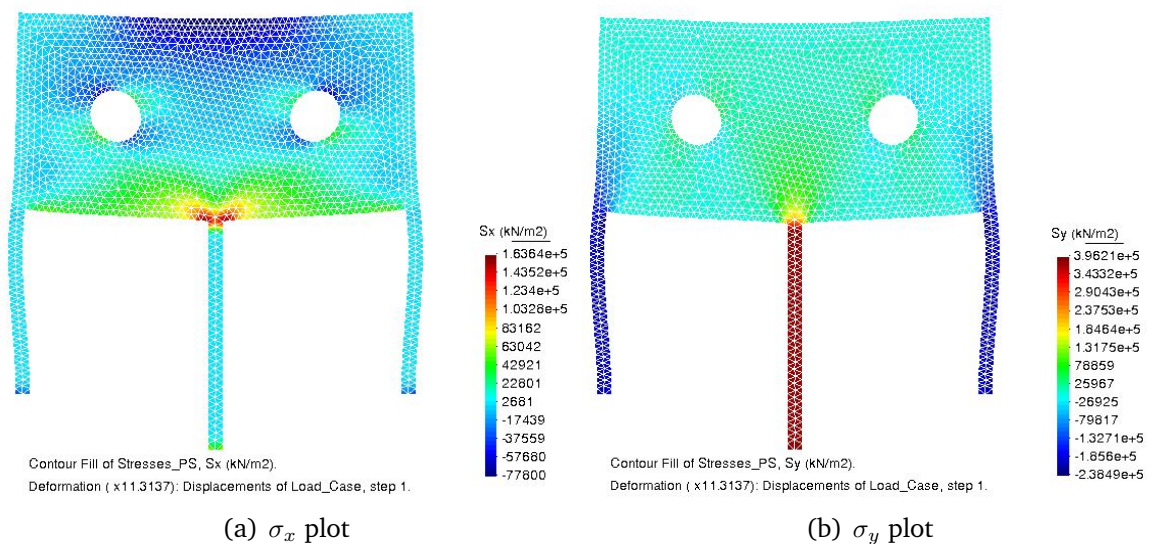

Figure 26: Results: Stress distribution plot in the structure with $\delta = 0.1\ m$

2.3. Comparison of the results

The stress concentration in the case of $\delta = 0$, can be seen at the base of the plate in case of σ_x and throughout the concrete plate for σ_y . With the subsequent increase in the deformation of the central column, we see a greater tendency of the stresses to move from the concrete plate and concentrate in the central column. This also shows that the central column is the main support for the structure and takes all the load with low resistance due to subsequent deformations. We can also predict a buckling behaviour in the structure due to the deformation of the central column. As the central column deforms the load shifts to the other two columns which starts experiencing compression.

Also as expected the distribution of the y -displacement relates directly to the deformation in the central column. With subsequent deformations, the concrete structure would tend to collapse as the y -displacement of the structure is increasing proportionally with each step of deformation.

Exercise 3: Plate with ventilation hole

The structure represents a reinforced concrete plate with simple supports. This plate possesses a hole for a ventilation pipe. Due to a change in the initial project, the design load for which the plate was calculated increased significantly.

This motivated the placement of a metal reinforcement sheet on both sides of the plate in the area of the hole. Analyse the state of stress in the plate and the metal reinforcement sheets. Assume the plane stress hypothesis. Use quadrilateral elements with four nodes.

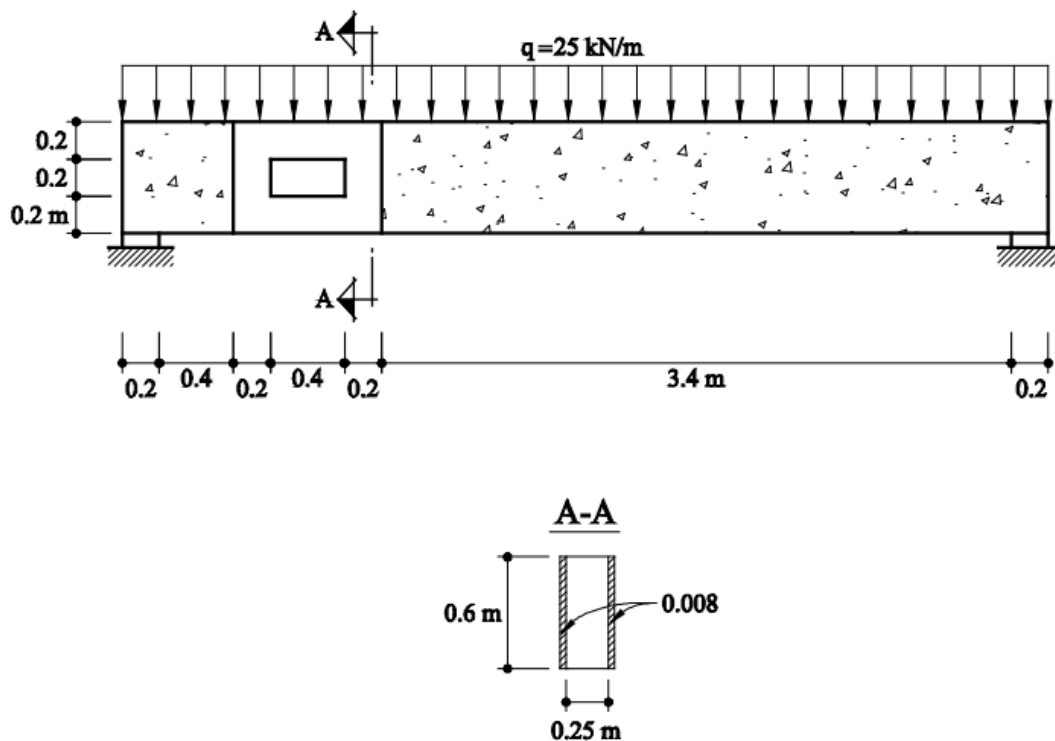

Figure 27: Plate with ventilation hole

Solution:

3.1. Purpose of the example

The objective of this exercise is to analyse the effect of placement of a metal reinforcement sheet on both sides of the concrete plate in the area of the hole.

3.2. Analysis

3.2.1 Pre-processing

(i) Geometry

The first step of pre-processing is to model the geometry of the concrete plate and metal sheet as two different material layers as per the given dimensions in GiD shown in Figure 28.



Figure 28: Defining the geometry

(ii) Data

Once the geometry is defined, we apply the given data to the model.

Problem type

As stated in the problem, we assume the plane stress hypothesis for this exercise and select the plane state problem type from the Ramseries Educational 2D module.

Boundary Conditions

Next, we define the boundary conditions for the problem as shown in Figure 29. For the given problem, the structure is simply supported with a distributed force of 25 kN/m acting on top of the plate.



Figure 29: Boundary conditions

Material

The material properties of the concrete and steel are defined and depicted with the given parameters shown in Figures 30 and 31.

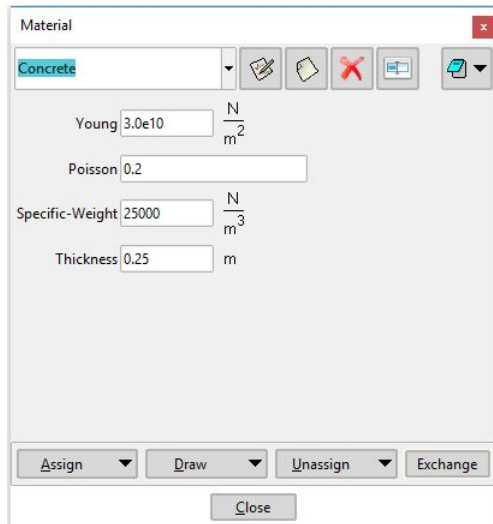

(a) Material properties for concrete

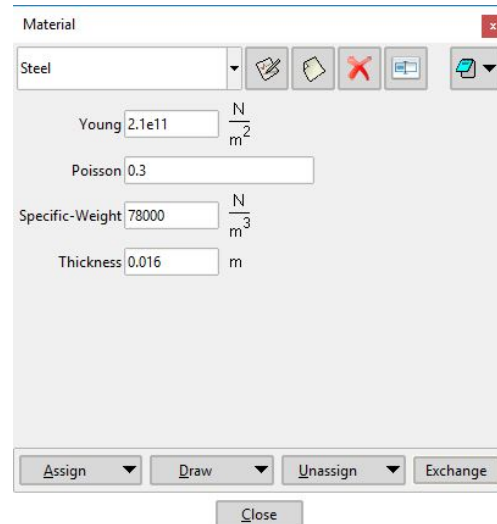

(b) Material properties for steel

Figure 30: Material properties



Figure 31: Geometry depicting assigned materials

Problem Data

In the problem data definition, we consider the self weight of the plate with a scale factor of 1.0. Figure 32 shown the necessary data used for this problem.

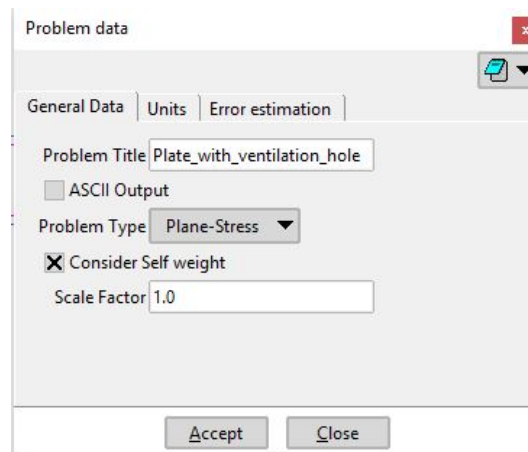

Figure 32: Problem data

Mesh

In this problem, a structured mesh is generated with linear quadrilateral elements. Figure 33 shows the structured mesh used with 4 noded quadrilateral elements, which is conformal at the interface between steel and concrete material.

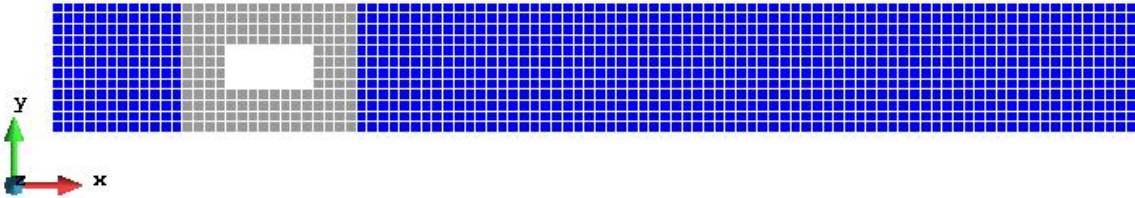

Figure 33: Structured mesh generation

3.2.2 Processing

In this section, we calculate the solution of the problem for two cases: without the metal reinforcement sheet and with inclusion of the metal reinforcement sheet. The material specification is modified according to the problem to be solved.

3.2.3 Post-processing

The results obtained for the stresses in the horizontal and vertical directions are shown below for both the cases in the deformed configuration:

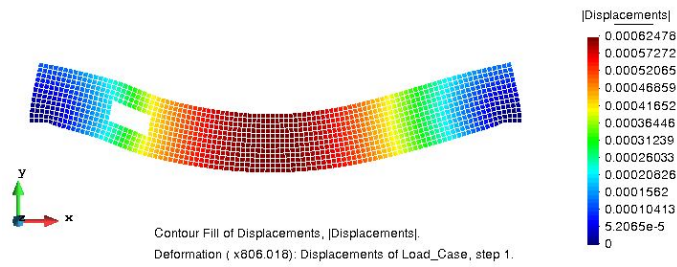

(a) Case 1: without metal reinforcement sheet

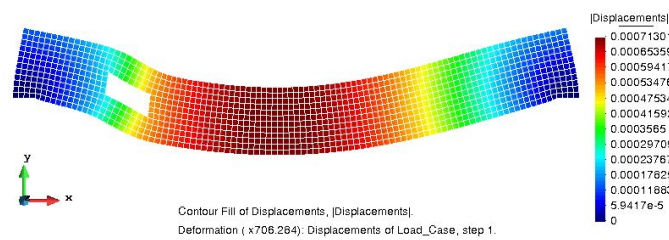

(b) Case 2: with metal reinforcement sheet

Figure 34: Results: deformed configuration of the structure

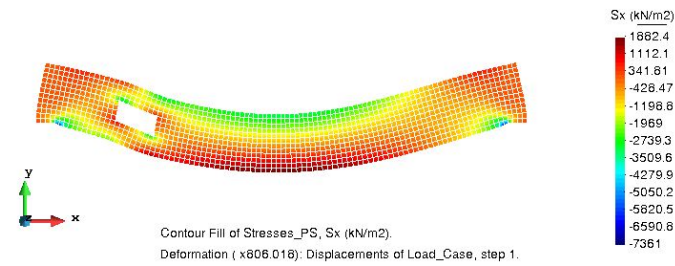

(a) Case 1: without metal reinforcement sheet



(b) Case 2: with metal reinforcement sheet

Figure 35: Results: σ_x plot on the structure in the deformed configuration



(a) Case 1: without metal reinforcement sheet

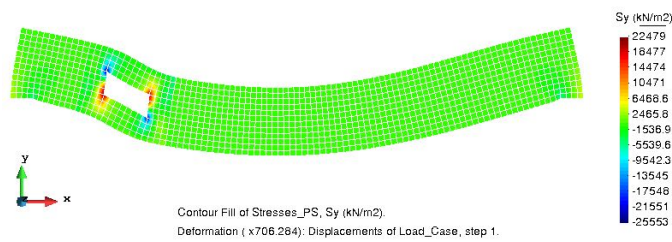

(b) Case 2: with metal reinforcement sheet

Figure 36: Results: σ_y plot on the structure in the deformed configuration

3.3. Comparison of the results

Firstly, the plots clearly depicts the need of using the reinforcement sheet. The steel sheet undergoes higher stress and provides better support to the concrete structure. As expected, higher displacements are observed in the middle of the structure which is simply supported at its ends leading to higher stresses at the support points as well.

When the metal reinforcement is not placed in the structure, the stress is concentrated in the middle of the concrete plate owing to a strong potential for a collapse. By using the steel sheet, the stress concentration shift to the metal part (around the ventilation hole), which can be easily noticed in the plots for σ_x and σ_y , making the structure more resistant to stress related failures. Therefore using the reinforcement is overall a good design optimisation.

Exercise 4: Prismatic water tank

The structure in the figure represents the cross-section of the wall of a rectangular water tank made of reinforced concrete. The tank is used to store drinking water. Analyse the state of stress of the cross-section of the tank. Consider the base slab to be elastically supported by the ground. Use the hypothesis of planar deformation. Use quadrilateral elements with four nodes.

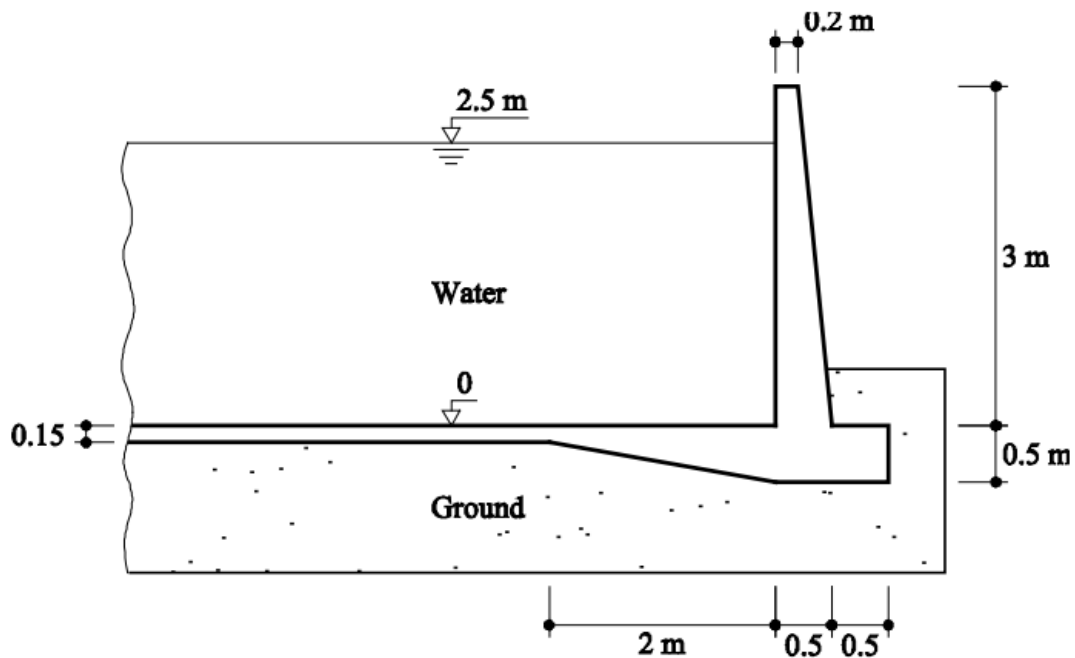

Figure 37: Prismatic water tank

Solution:

4.1. Purpose of the example

The objective of this exercise is to analyse the stress state of the rectangular water tank cross-section.

4.2. Analysis

4.2.1 Pre-processing

(i) Geometry

The first step of pre-processing is to model the geometry of the rectangular water tank as per the given dimensions in GiD shown in Figure 38.

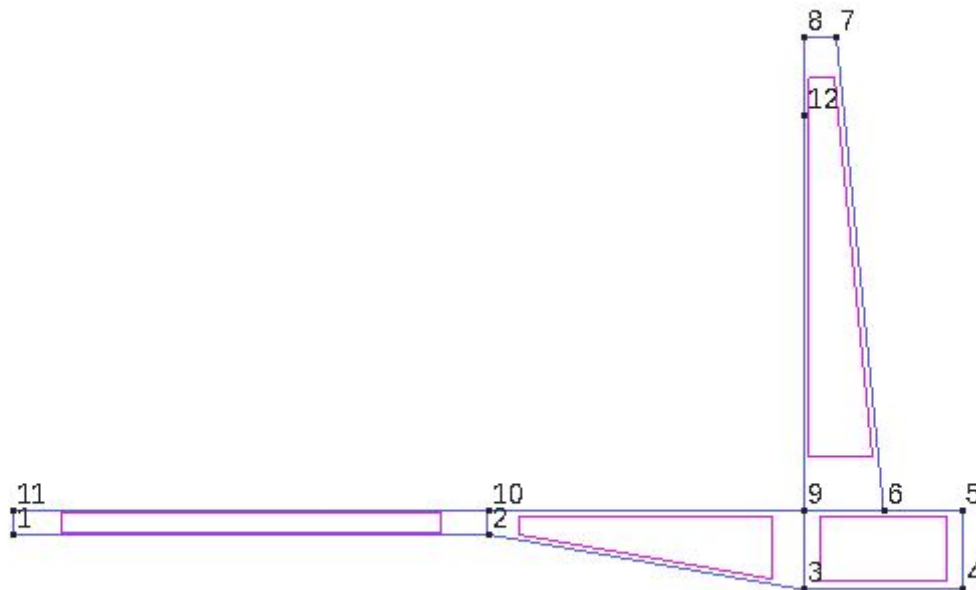

Figure 38: Defining the geometry

(ii) Data

Once the geometry is defined, we apply the given data to the model.

Problem type

As stated in the problem, once again we assume the plane deformation hypothesis for this exercise and select the plane state problem type from the Ramseries Educational 2D module.

Boundary Conditions

Next, we define the boundary conditions for the problem as shown in Figure 39. For the given problem, firstly a symmetry condition is applied for an infinite extension by restricting the motion in x -direction. Next, since the ground elastically supports the base slab, load coefficient given in the problem is applied. Finally, a linear distribution of the weight of the water is imposed on all sides of the tank equivalent to 24.525 kN/m^2 . Considering unit thickness, a linear force of 24.525 kN/m has the same effect as the pressure on the wall and bottom of the water tank.

Material

The material properties of the concrete structure is defined with the given parameters shown in Figure 40.

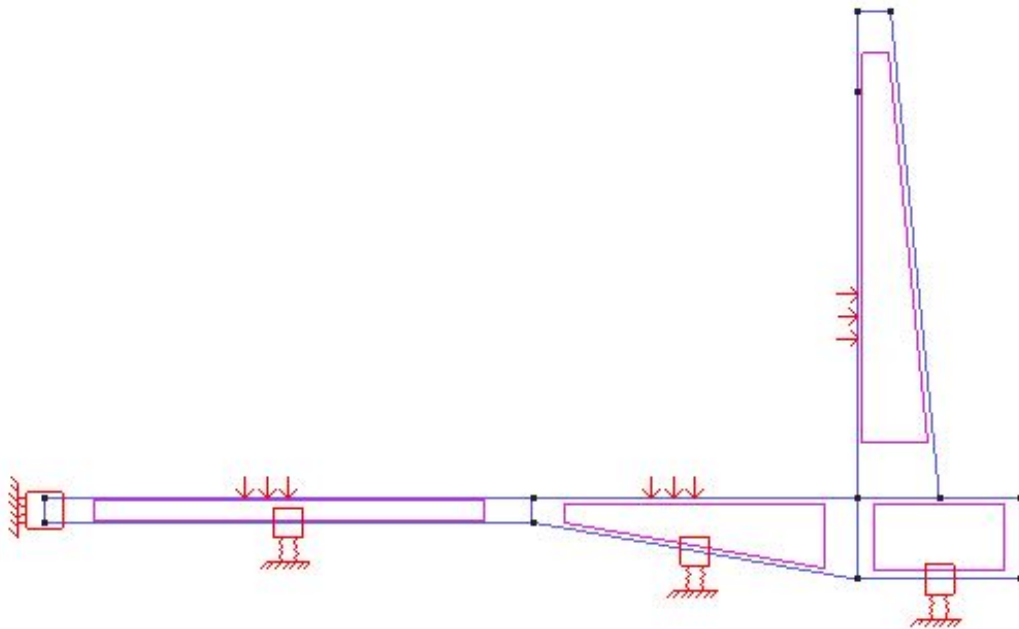

Figure 39: Boundary conditions

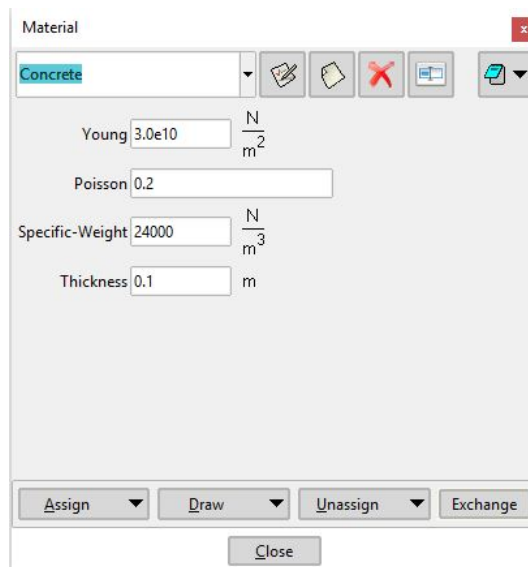

Figure 40: Material properties

Problem Data

In the problem data definition, we consider the self weight of the plate with a scale factor of 1.0 with plane-strain as the problem type. Figure 41 shown the necessary data used for this problem.

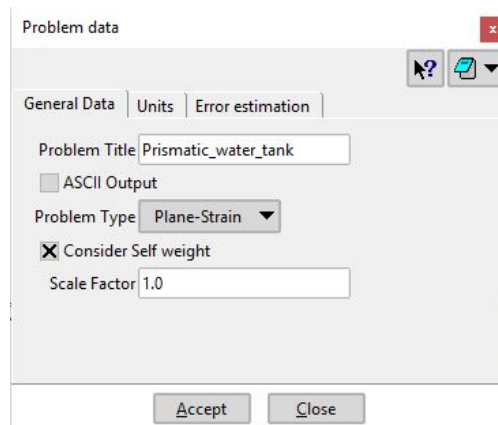

Figure 41: Problem data

Mesh

In this problem, a structured mesh is generated with linear quadrilateral elements. Figure 42 shows the structured mesh used with 4 noded quadrilateral elements.

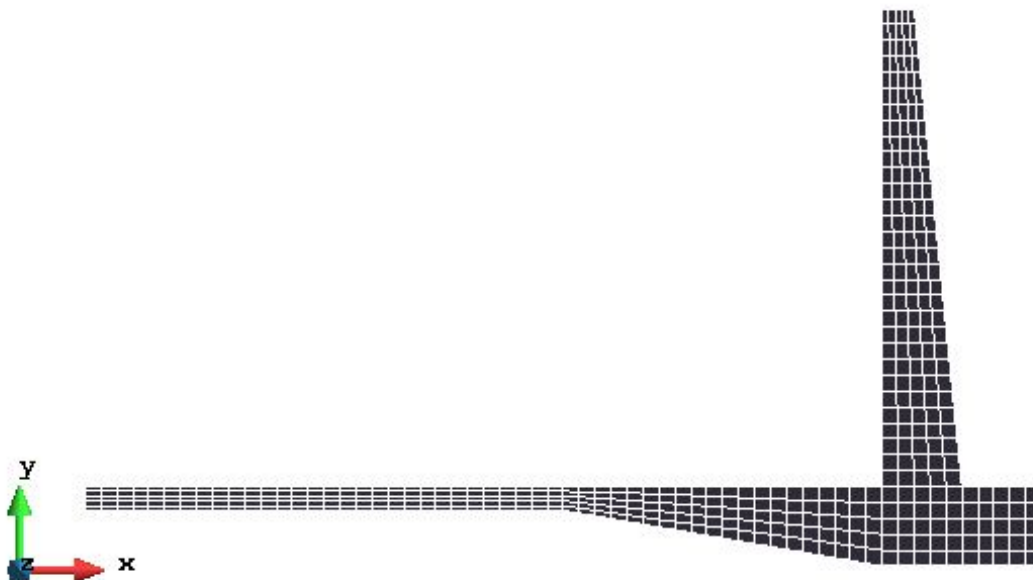

Figure 42: Structured mesh generation

4.2.2 Processing

In this section, we calculate the solution of the problem.

4.2.3 Post-processing

The results obtained for the stresses in the horizontal and vertical directions are shown below in the deformed configuration:

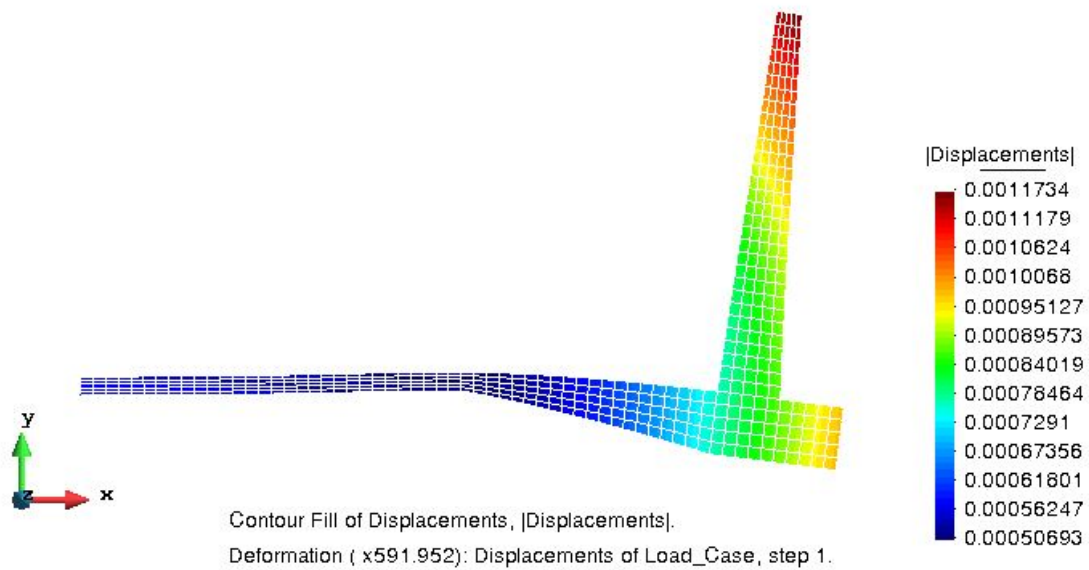

Figure 43: Results: deformed configuration of the structure

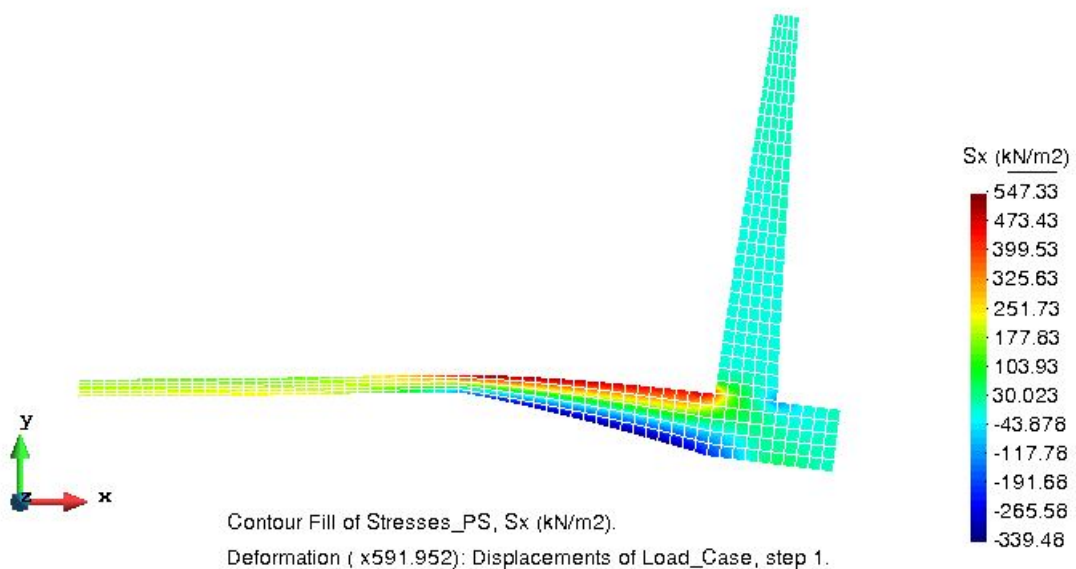

Figure 44: Results: σ_x plot on the structure in the deformed configuration

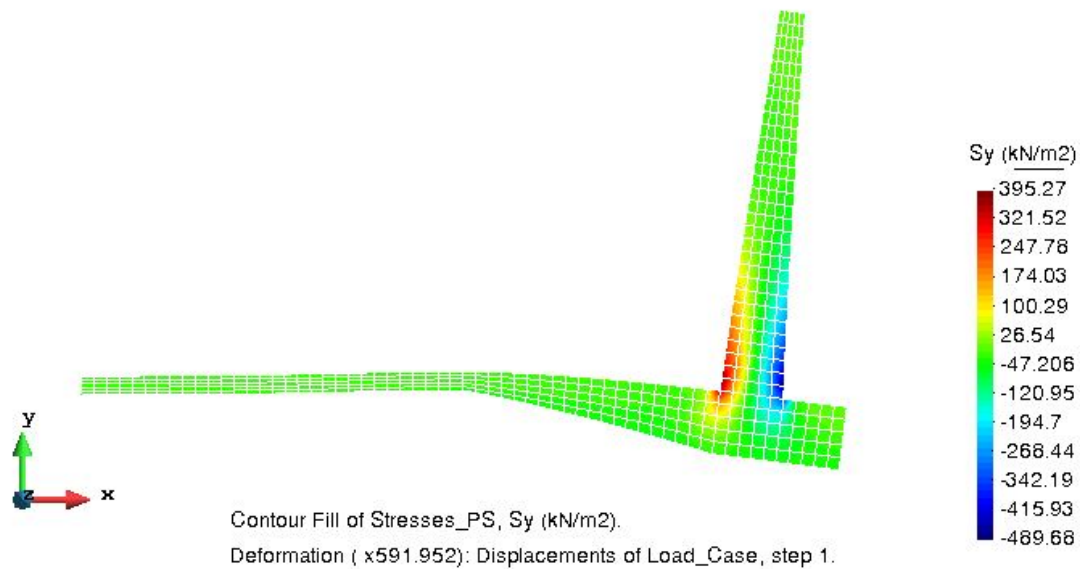

Figure 45: Results: σ_y plot on the structure in the deformed configuration

4.3. Comparison of the results

Firstly, it is easily noticed from the plots that the highest deformation is on the vertical wall of the structure. The pressure applied by the water on the structure induces high stresses. Therefore, the stress concentration in this structure can be seen at the face of the structure (for σ_x) and the lower wall of the structure (for σ_y). The deformation caused by the water pressure and the ground results in a bending deformation (shown in the deformed configuration) where high compression is experienced by the side close to the ground and high tension on the side facing the water pressure. This is an intuitive behaviour of the structure due to the water pressure forces on the structure in addition to ground reaction forces.