

UNIVERSITAT POLITÈCNICA DE CATALUNYA

MASTER OF SCIENCE IN COMPUTATIONAL MECHANICS

COMPUTATIONAL STRUCTURAL MECHANICS AND DYNAMICS

---

# Practice 1

## Plane State

---

*Authors:*

Carlos Eduardo Ribeiro Santa Cruz Mendoza

Chinmay Khisti

Valeria Agustina Felipe Ramudo

March 14, 2019



**UNIVERSITAT POLITÈCNICA  
DE CATALUNYA  
BARCELONATECH**

# 1 Thin plate under dead weight

Analyze the thin plate shown in the figure, which is submitted to its self weight. Compare the obtained results with the solution that is obtained when refining the mesh.

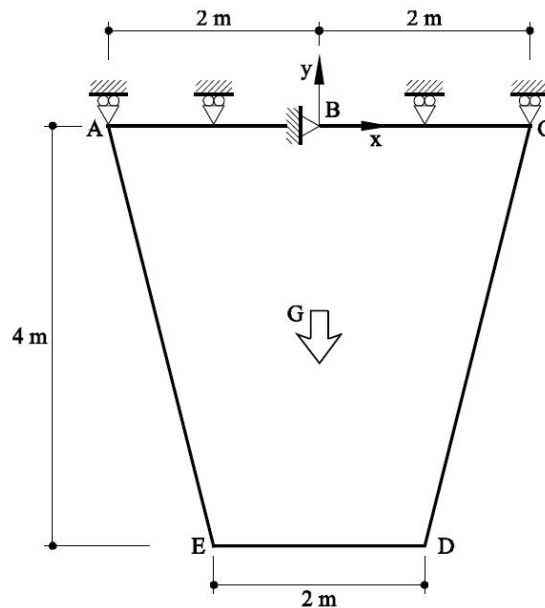
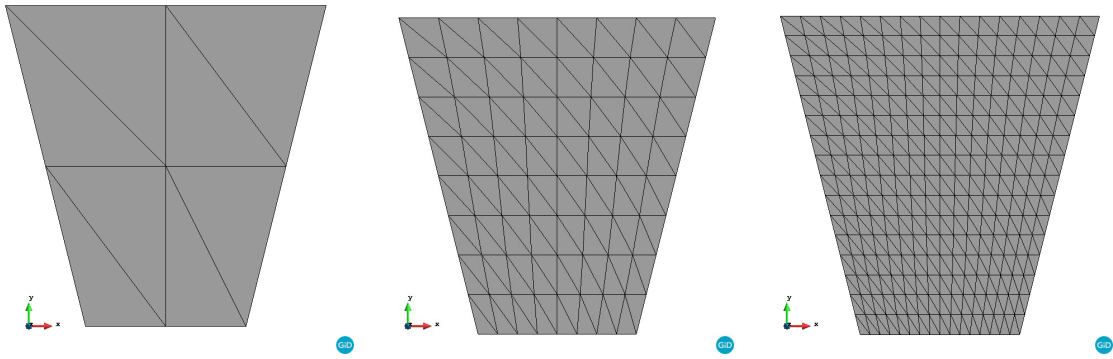

Figure 1.1: Problem geometry

## 1.1 Types of meshes

1. The figures below shows the different types of meshes used for triangular elements with 3 and 6 nodes. In the first figure the mesh is structured using 2 segments for the horizontal lines and 2 for the vertical lines, in the middle one the mesh is structured using 8 segments for the horizontal lines and 8 for the vertical lines and in the last one the mesh is structured using 16 segments for the horizontal lines and 16 for the vertical lines.



- The figures below shows the different types of meshes used for quadrilaterals elements with 4, 8 and 9 nodes. In the first figure the mesh is structured using 2 segments for the horizontal lines and 2 for the vertical lines, in the middle one the mesh is structured using 8 segments for the horizontal lines and 8 for the vertical lines and in the last one the mesh is structured using 16 segments for the horizontal lines and 16 for the vertical lines.

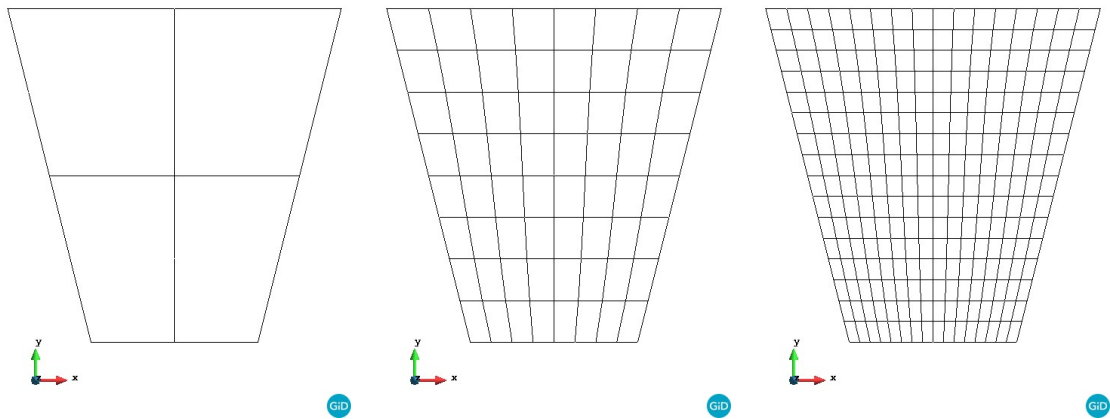

## 1.2 Postprocessing

In this section it is shown the graphs of  $\sigma_y$  and the displacement on the y direction for the first type of elements (triangle with three nodes) for the three different types of meshes used. This process is repeated for the four remaining types of elements.

- Displacements.

In the first figure we have 8 triangular elements, in the middle one 128 and in the last one 512:

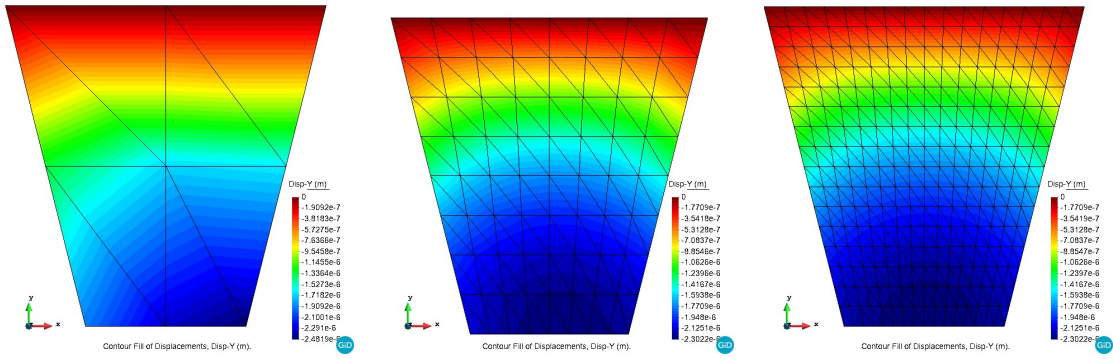

2.  $\sigma_y$

In the first figure we have 8 triangular elements, in the middle one 128 and in the last one 512:

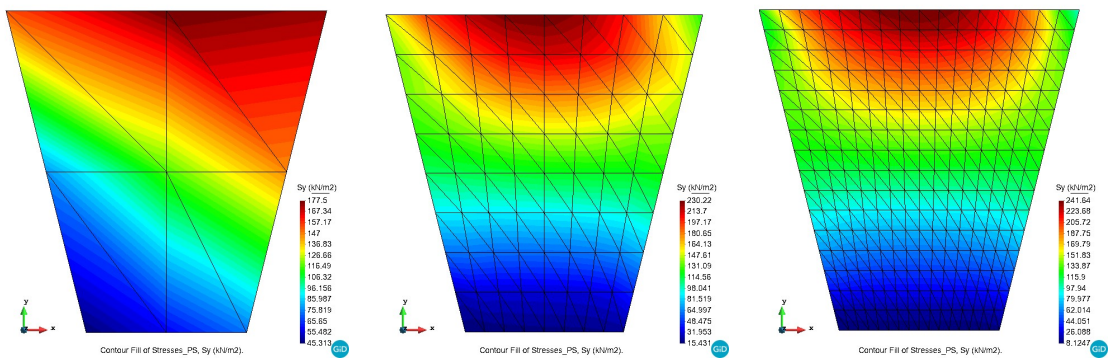

The convergence graph is obtained by comparing the results to the following values:

$$\begin{cases} \text{Center of side ED Displ} - Y = 2.26e - 6m \\ \text{Point B } \sigma_y = 0.247 \frac{MN}{m^2} \end{cases}$$

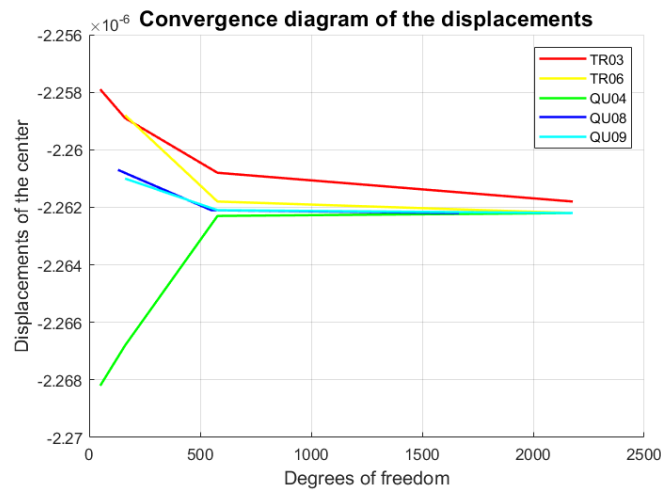

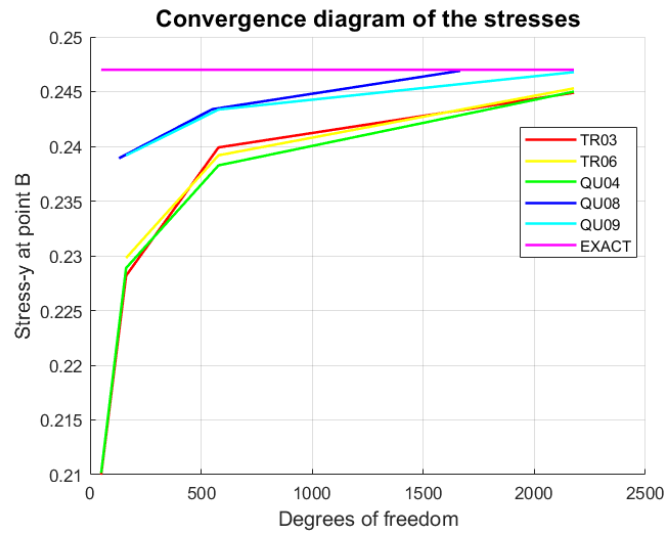

## 2 Plate with two sections

The structure in the figure presents a reinforced concrete plate with two holes, supported by three columns. The central column undergoes a displacement  $\delta$  equal to 1cm due to sag of the foundation caused by a leakage in some pipes nearby.

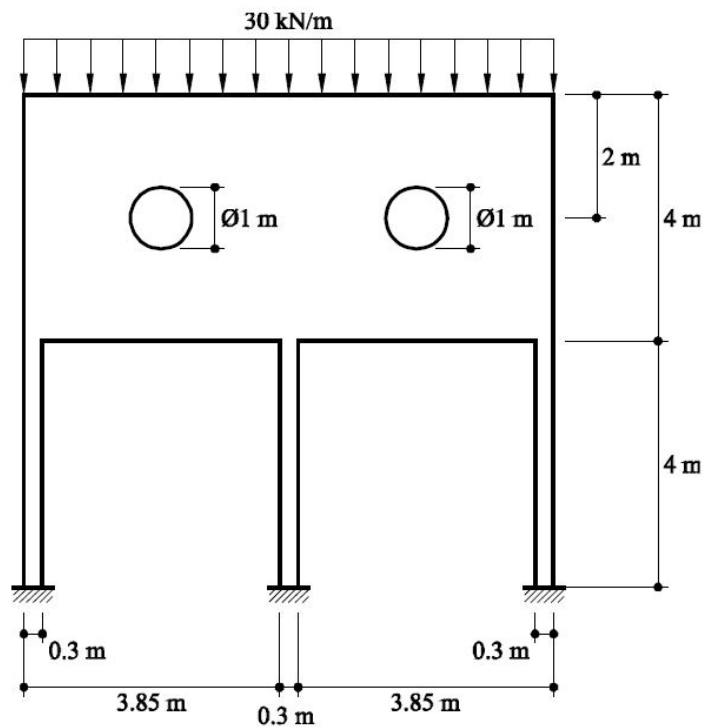

Figure 2.1: Problem geometry

Problem data:

$$\begin{cases} E = 3.0e10 \frac{N}{m^2} \\ \nu = 0.2 \\ t = 0.20m \end{cases}$$

In order to appreciate the influence of the displacement of the central column, two models were made: one with the imposed displacement on the central column and one without it, to be able to compare them.

The mesh used for both models was the following:

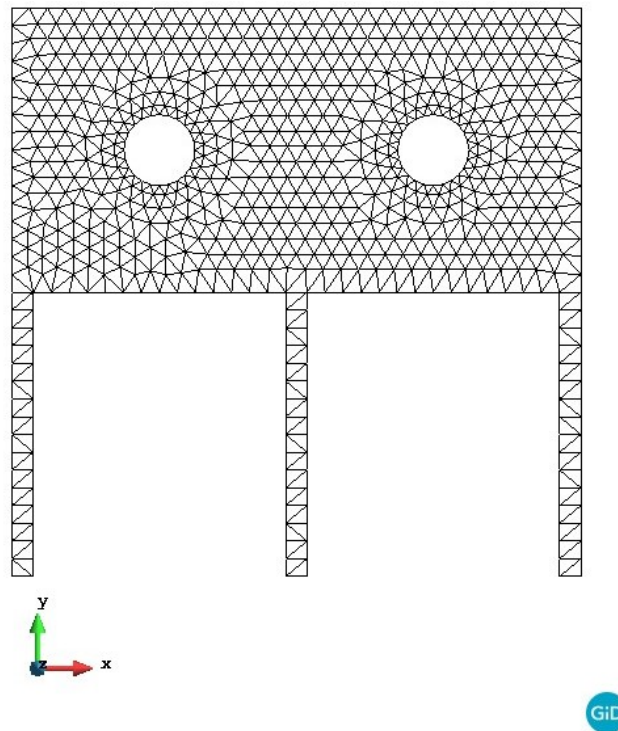
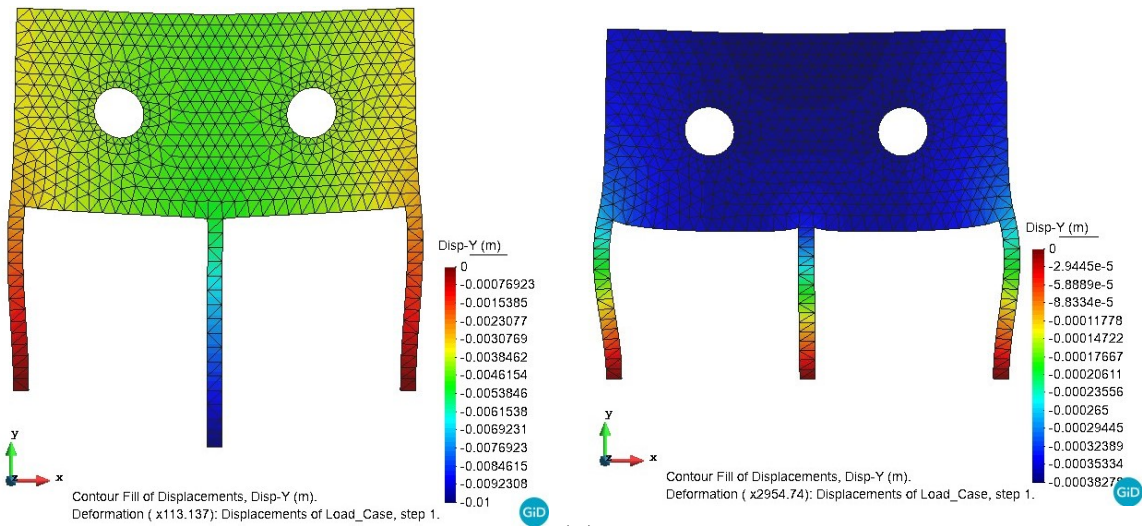

Figure 2.2: Discretization

The following figures show the displacements in the y-direction values:



(a) Displacements with imposed displacement in the central column. (b) Displacements without imposed displacement.

Figure 2.3

The following figures show the  $\sigma_y$  values:

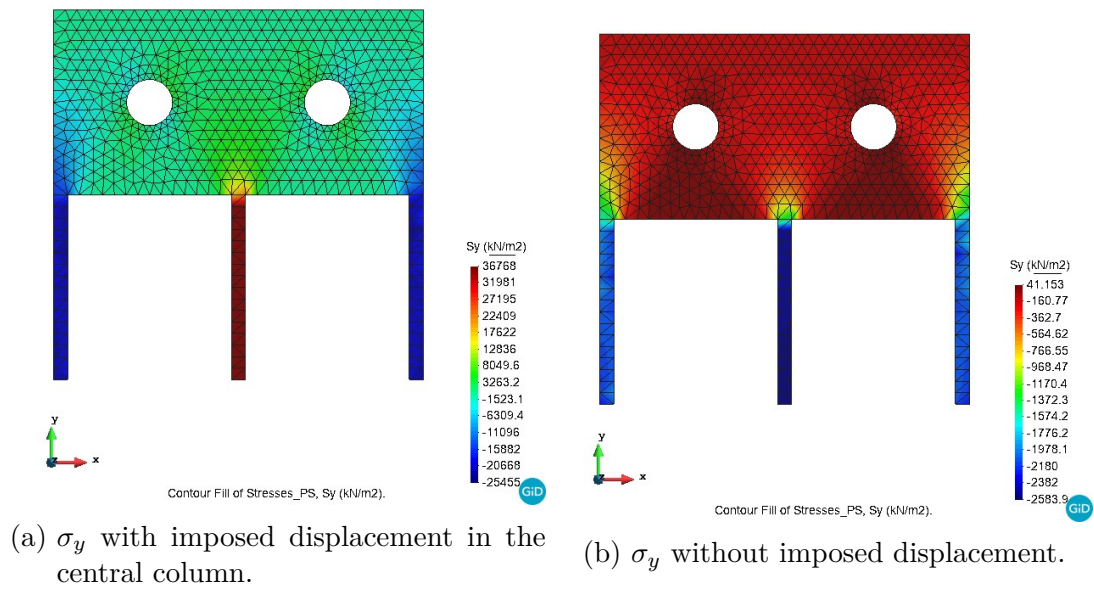

Figure 2.4

The results show that in the model with displacement in the intermediate column, in contrast to the results where there are no displacements, the tension values increases almost 15 times approximately.



The following figures show the  $\sigma_x$  values:

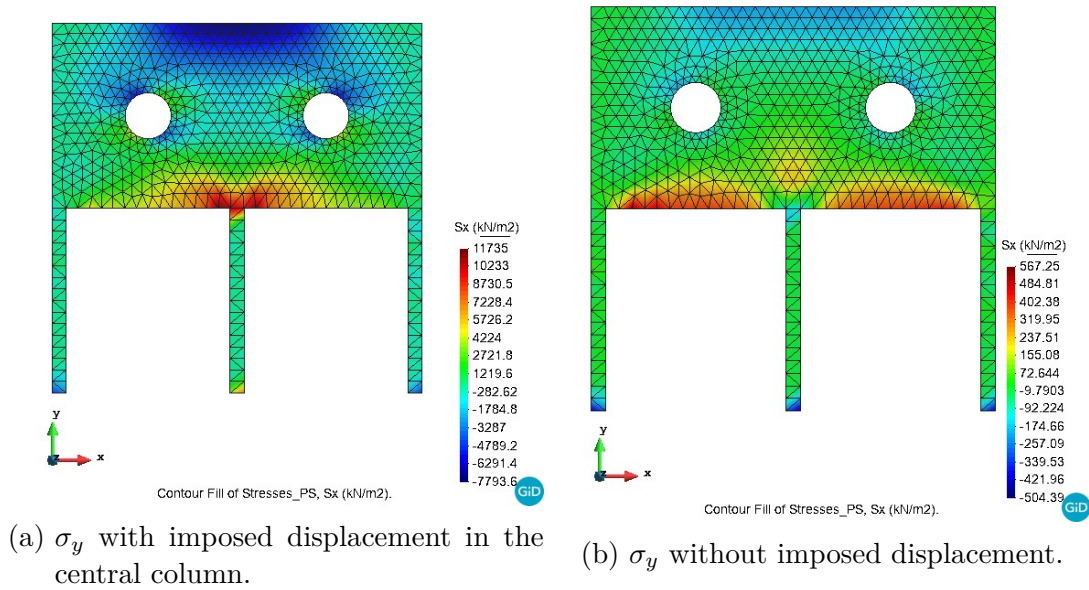

Figure 2.5

If we compare now the values of  $\sigma_x$  between the two models it is possible to see how again the values in the model with the displacement on the central column are 50 times bigger at the upper end of it than the ones with no displacement.

### 3 Plate with ventilation hole

The structure represents a reinforced concrete plate with simple supports. This plate possesses a hole for a ventilation pipe. Due to a change in the initial project, the design load for which the plate was calculated increased significantly. This motivated the placement of a metal reinforcement sheet on both sides of the plate in the area of the hole.

Analyze the state of stress in the plate and the metal reinforcement sheets. Assume the plane stress hypothesis. Use quadrilateral elements with four nodes.

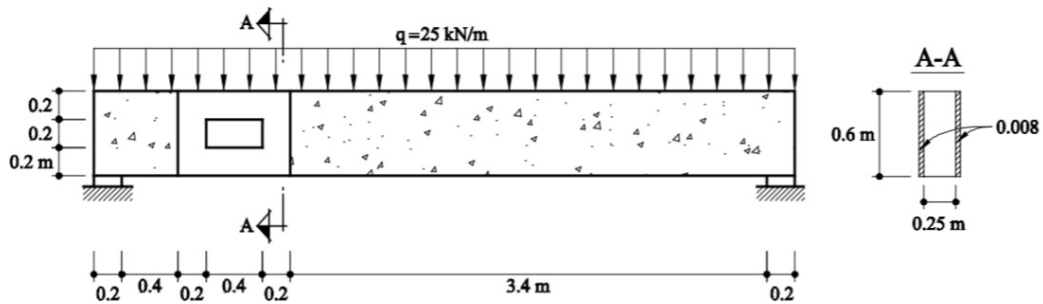

Figure 3.1: Problem geometry

Material properties:

Material	$E(N/m^2)$	$\nu$	$t(m)$
Concrete	$3.0e10$	0.2	0.25
Steel	$2.1e11$	0.3	0.016

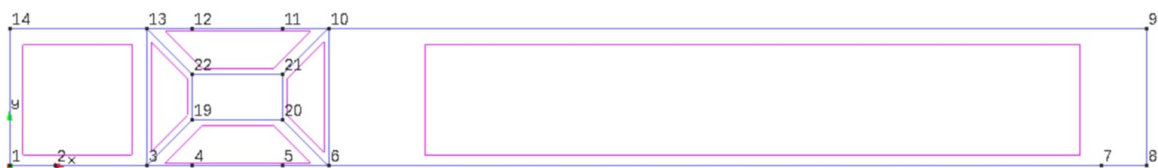

Figure 3.2: Geometry

Boundary conditions: A uniformly distributed load of magnitude 25 KN/m is applied at top portion of the plate and fixed support is applied at both the ends of the plate as shown in the figure 3.1.

The discretization process is carried out with the geometry by considering quadrilateral elements with four nodes as seen in figure 3.3. Resultant mesh consist of 2275 elements with 2508 nodes.

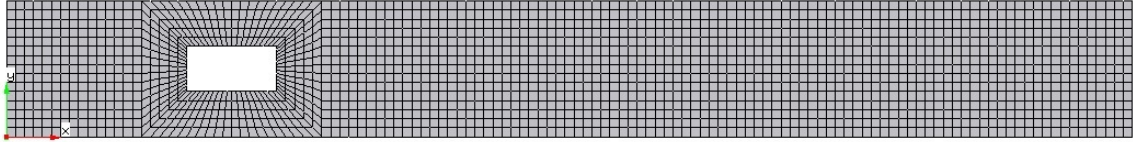

Figure 3.3: Mesh

After solving the problem following results were observed in the post processing part. Displacements in X and Y directions can be seen in figure 3.4 and 3.5, maximum displacement observed was 0.139 mm which is significantly low.

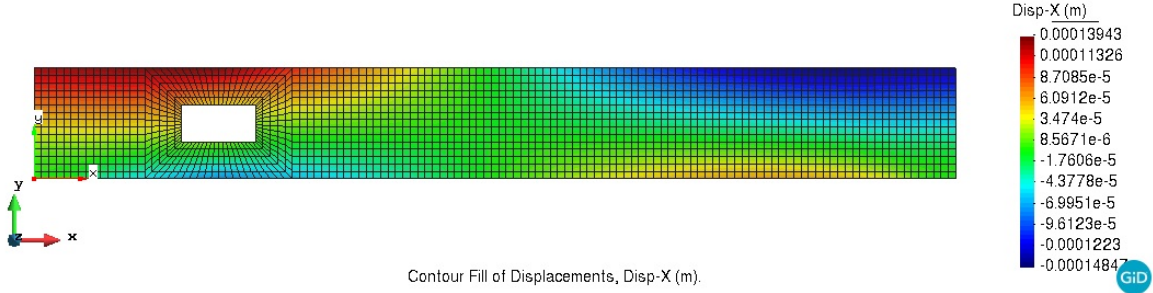

Figure 3.4: Displacement in X direction

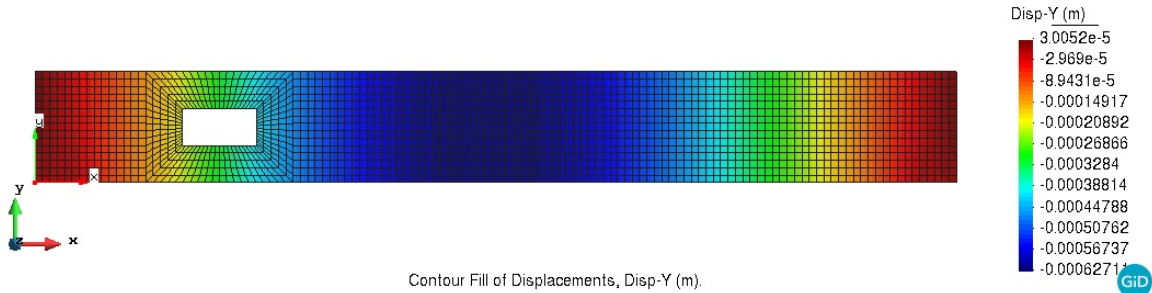

Figure 3.5: Displacement in Y direction

The plots for the normal stress in X (figure 3.6), Y (figure 3.7) direction and Von Mises stress (figure 3.8) shows maximum stress observed were under elastic limit thus can be considered safe.

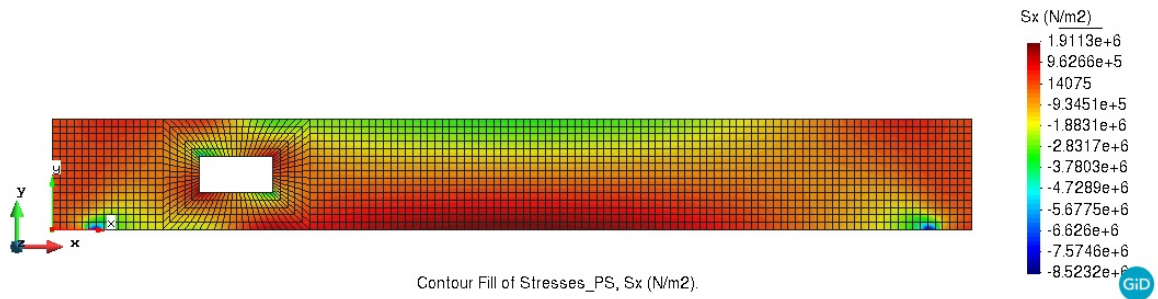

Figure 3.6: Normal stress in X direction

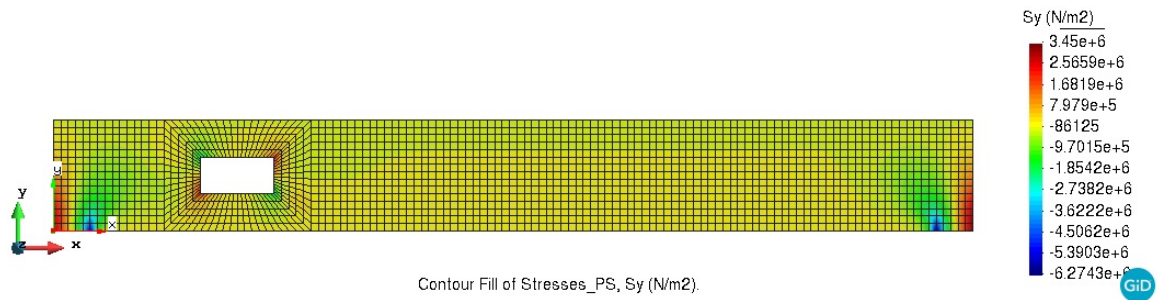

Figure 3.7: Normal stress in Y direction

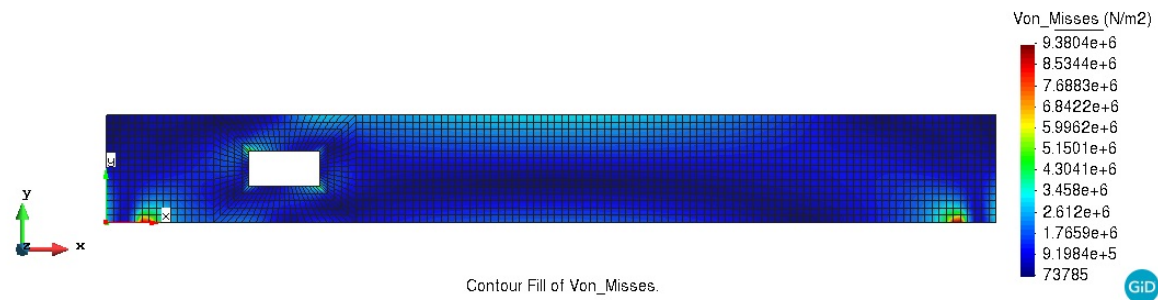

Figure 3.8: Von Mises stress

# 4 Prismatic water tank

The cross-section of a tank used to store drinking water is depicted on Figure 4.1. The tank is prismatic and, thus, symmetric, it's supported vertically by the ground and it stores a level of water of 2,5 meters.

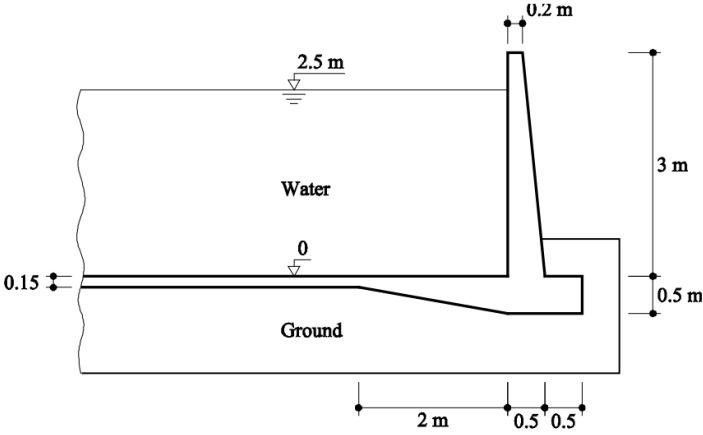
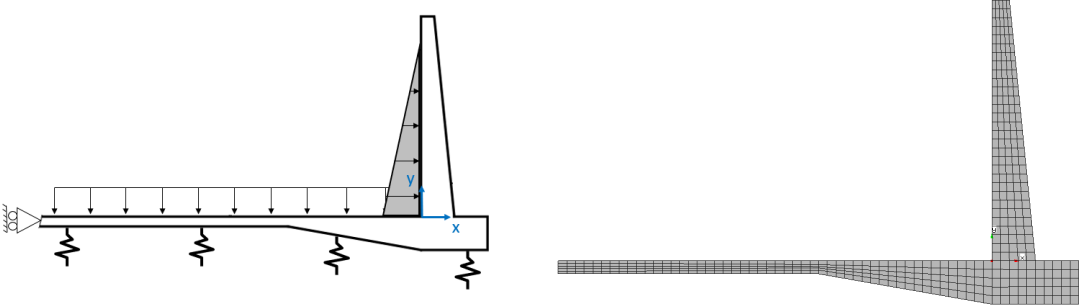

Figure 4.1: Problem geometry

In order to analyse the state of stress of the cross-section the physical system was modeled and discretized as indicated on Figure 4.2.

On the idealization, seen on Figure 4.2a, the 3-D tank was simplified to a 2-D plane strain model, with the assumption that the strains on the  $z$ -direction are negligible. The water volume was exchanged by a uniform load over the lower surface of the tank (with



(a) Idealization

(b) Discretization

Figure 4.2: Computational model

a linear pressure with a value of the hydro-static pressure  $\rho gh = 24426.5 \text{ N/m}$  and a linear load at the tank's wall varying from zero at the level of the water (2,5 m) to  $\rho gh$  on the bottom. The ground was replaced by a an elastic constraint with a load coefficient of  $50 \text{ N/m}^3$  and a symmetry constraint was imposed (arbitrarily 5 meters from the wall, due to the lack of information) on the middle of the tank, restricting it's displacement on the  $x$ -direction on the left end.

The discretization, as seen on Figure 4.2b, was made with linear quadrilateral elements, seeking the an aspect ratio of one, although not taking close attention to potential complicated spots, such as sharp corners, that could eventually need a local mesh refinement if greater accuracy was needed.

The displacements (given in meters) provoked by the loads are shown on Figure 4.3 with an multiplication factor of 500. They reach up to 1 mm on the top of the tank's wall, due to the lack of physical constraints on that region. As expected, there's a moderate displacement on the  $y$ -direction due to the weight of the water, compensated by the elastic behaviour of the ground, and a little more pronounced deformation on the  $x$ -direction, since there are no constraints other than the tank's rigidity on this direction, specially on the wall.

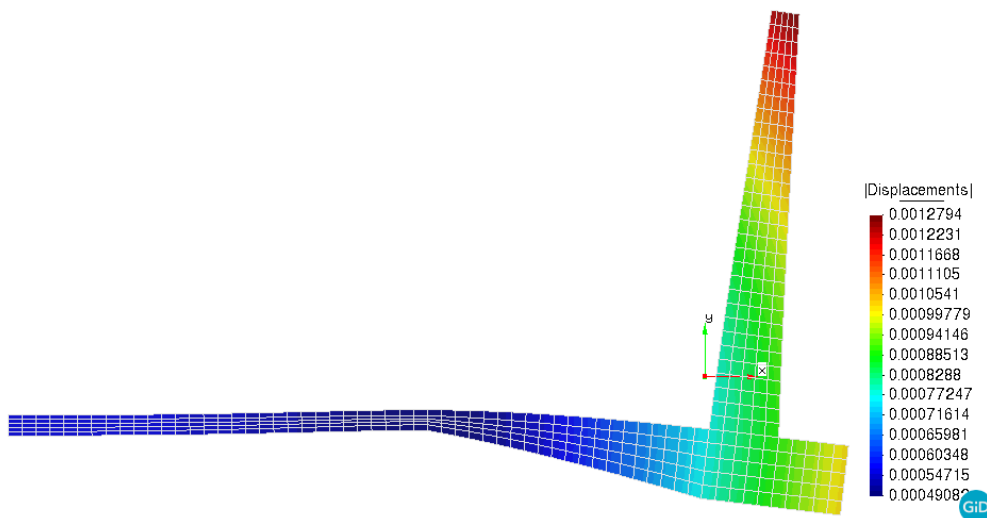

Figure 4.3: Displacements (500 factor)

The normal stresses on the  $x$ -direction are represented on Figure 4.4. The greatest value of tension stresses, reaching over  $600 \text{ kN/m}^2$ , are seen on the tank's bottom near the edge. This is due to the normal pressure the water exerts on the wall of the tank. The deformation on the positive direction of  $x$ , seen on Figure 4.3, “pulls” the bottom, while compressing the part in contact to the ground, as also clear on the figure.

The normal stresses on the  $y$ -direction are represented on Figure 4.5. Similarly to the  $x$ -direction, the pressure exerted on the wall deforms it in such a way that it suffers traction forces on the side in contact with water and, consequently, compression forces on the opposite side.

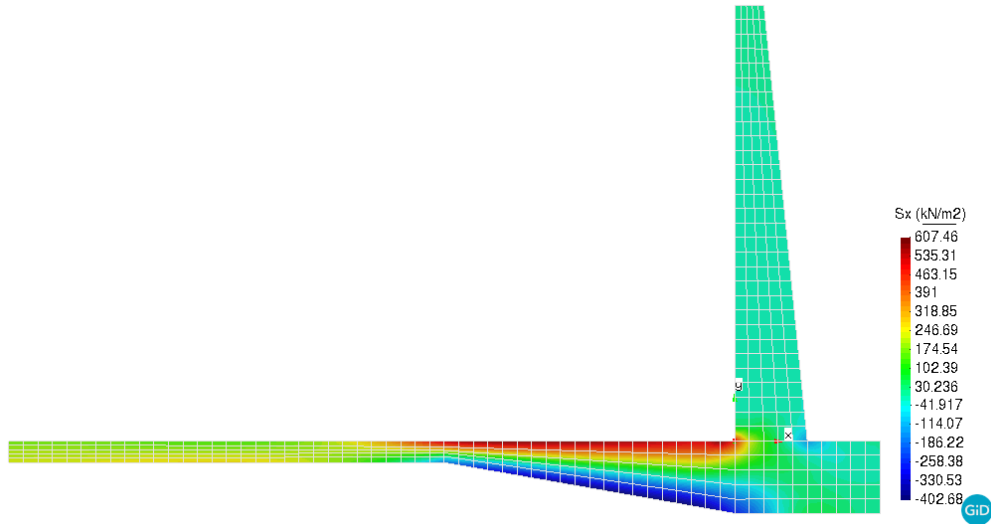

Figure 4.4: Normal stresses on the  $x$ -direction

The principal stresses, depicted as vectors (Tension, red and Compression, blue) in Figures 4.6, 4.7 and 4.8, confirm what was discussed previously. The regions around the connection between bottom and the wall of the tank are the ones under the greatest stresses. Mostly traction on the surfaces touching water and compression on the opposite surfaces.

The results obtained from the GiD solver indicate, primarily, that to obtain more reliable results a mesh test should be performed initially by a refinement around the sharp corner under the greatest stresses. As a second conclusion, if the obtained stresses and displacements are not admissible, one possible solution could be the reinforcement of the walls touching water (since concrete already holds compression specially well).

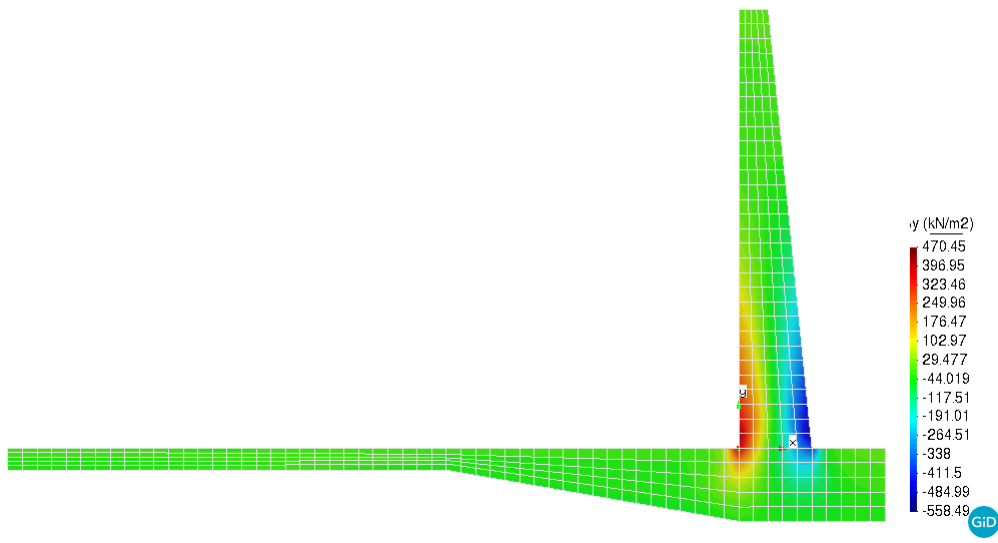

Figure 4.5: Normal stresses on the  $y$ -direction

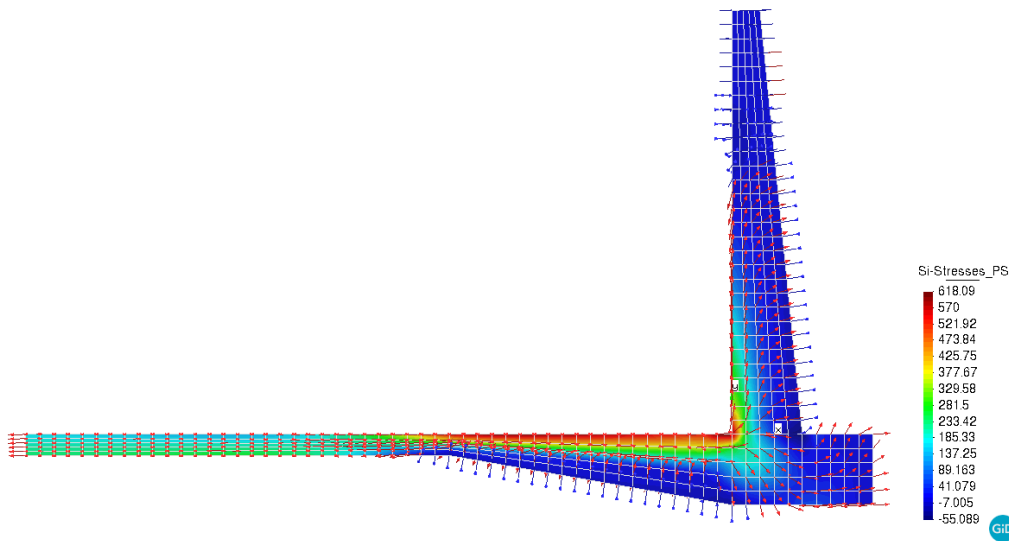

Figure 4.6: Principal stress  $i$



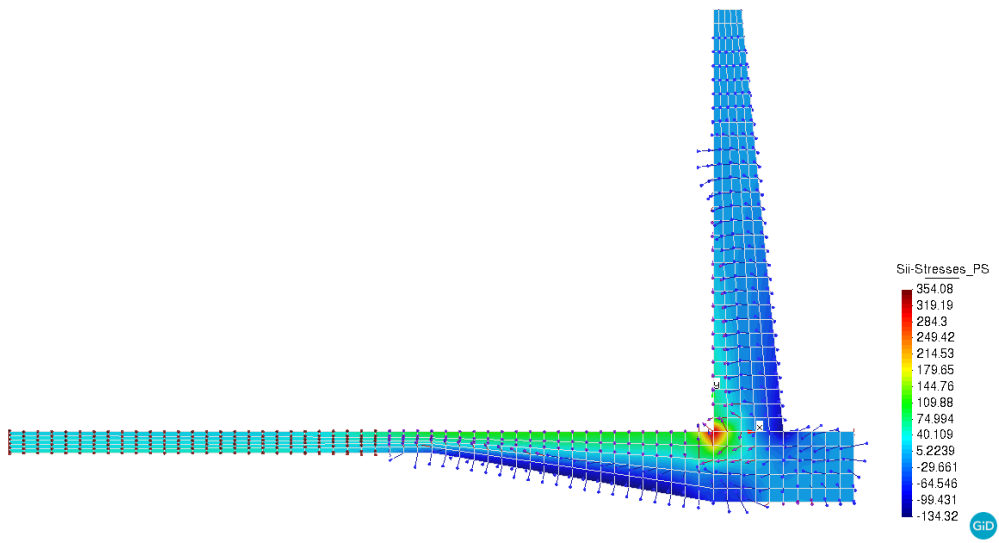

Figure 4.7: Principal stress ii

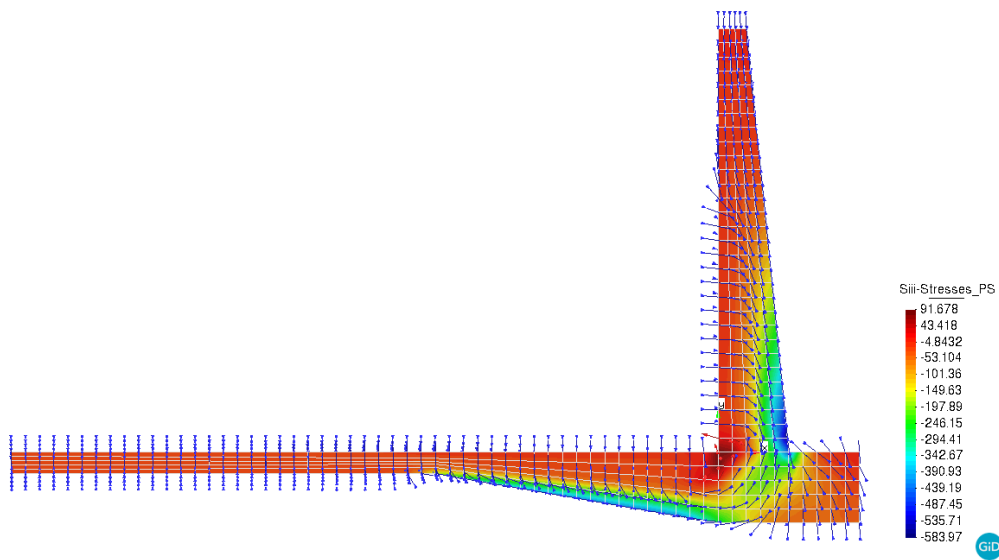

Figure 4.8: Principal stress iii