

Computational Structural Mechanics and Dynamics

Assignment 8

Author: Anil Bettadahalli Channakeshava

18/04/2016

1 PLATES

Assignment 8.1(a)

In this part of the question it was asked to define what kind of strategy (theory, elements, integration rule, boundary conditions, etc) will be used for the below given figure.

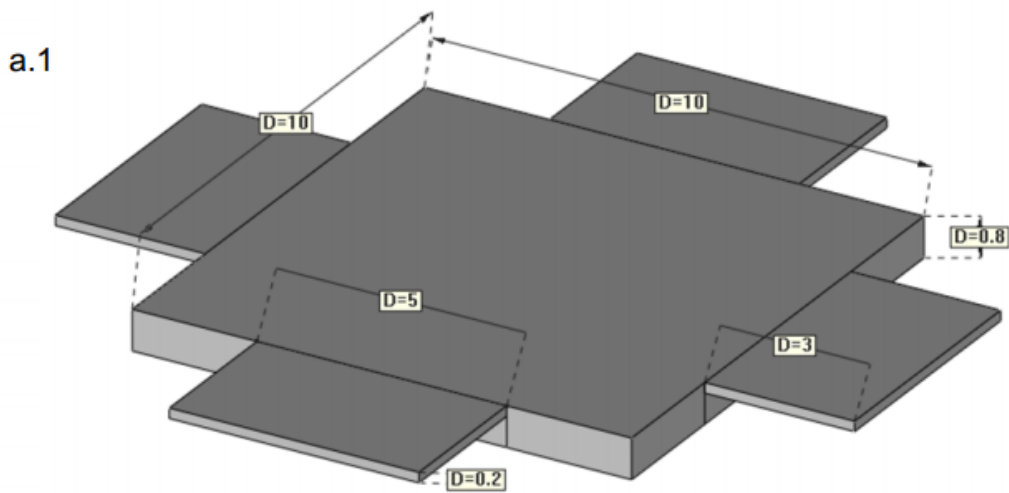

From above figure, the 'thickness/width' ratio for two sizes of plates are as follows:

1. Small plates (4) attached to center plate : thickness/width = $0.2/3 = 0.06$
2. Center plate : thickness/width = $0.8/10 = 0.08$

From the above data, we can see that thickness/width ratio is less than 0.1, which gives us the information that they are thin plates.

Hence we can use the '*Classical Kirchoff Plate theory*' in which transverse shear deformation is neglected and only bending effects are considered .

Type of elements : 4 noded quadrilateral MZC plate element (for good convergence use 64 or more elements mesh)

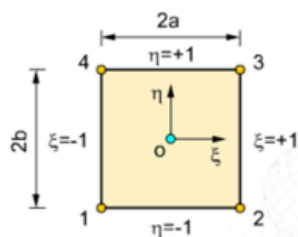

Where for MZC element,

$$w = \sum_{i=1}^4 [N_i w_i + \bar{N}_i \left(\frac{\partial w}{\partial x}\right)_i + \bar{\bar{N}}_i \left(\frac{\partial w}{\partial y}\right)_i]$$

$$N_i = ((1 + \xi_i \xi)(1 + \eta_i \eta)(2 + \xi_i \xi + \eta_i \eta - \xi^2 - \eta^2))/8$$

$$\bar{N}_i = a(\xi^2 - 1)(\xi + \xi_i)(1 + \eta_i \eta)/8$$

$$\bar{\bar{N}}_i = b(\eta^2 - 1)(\eta + \eta_i)(1 + \xi_i \xi)/8$$

Integration Rule : We can use 4 point gaussian quadrature rule.

Node	(ξ, η)	N_i	\bar{N}_i	$\bar{\bar{N}}_i$
1	(-1,-1)	$\frac{1}{8} (1 - \xi) (1 - \eta) (2 - \xi - \eta - \xi^2 - \eta^2)$	$\frac{1}{8} a (\xi^2 - 1) (\xi - 1) (1 - \eta)$	$\frac{1}{8} b (\eta^2 - 1) (\eta - 1) (1 - \xi)$
2	(1,-1)	$\frac{1}{8} (1 + \xi) (1 - \eta) (2 + \xi - \eta - \xi^2 - \eta^2)$	$\frac{1}{8} a (\xi^2 - 1) (\xi + 1) (1 - \eta)$	$\frac{1}{8} b (\eta^2 - 1) (\eta - 1) (\xi + 1)$
3	(1, 1)	$\frac{1}{8} (1 + \xi) (1 + \eta) (2 + \xi + \eta - \xi^2 - \eta^2)$	$\frac{1}{8} a (\xi^2 - 1) (\xi + 1) (1 + \eta)$	$\frac{1}{8} b (\eta^2 - 1) (1 + \eta) (\xi + 1)$
4	(-1, 1)	$\frac{1}{8} (1 - \xi) (1 + \eta) (2 - \xi + \eta - \xi^2 - \eta^2)$	$\frac{1}{8} a (\xi^2 - 1) (\xi - 1) (1 + \eta)$	$\frac{1}{8} b (\eta^2 - 1) (1 + \eta) (1 - \xi)$

Boundary conditions : Clamped at bottom of center plate, i.e,

$$w = 0$$

$$\theta_x = \left(\frac{\partial w}{\partial x}\right) = 0$$

$$\theta_y = \left(\frac{\partial w}{\partial y}\right) = 0$$



Assignment 8.1(b)

In this part of the question it was asked to define what kind of strategy (theory, elements, integration rule, boundary conditions, etc) will be used for the below given figure.

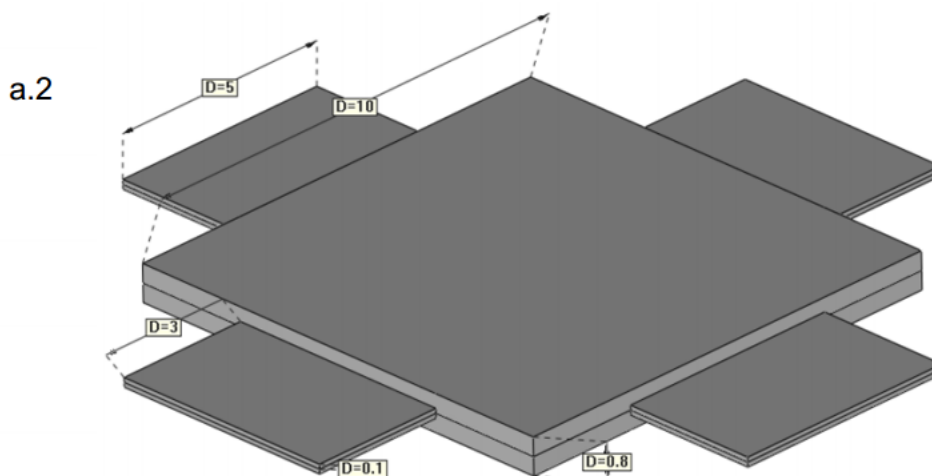

As we can see from above figure that the plates are being overlapped, which is the simplified model of previous model. And also we can observe that since 'thickness/width' ratio is less than 0.1, they are thin plates.

Even-though they are thin plates, due to overlapping of plates there will be effect of both bending moment and transverse shear deformation, and hence we can use '*Reissner-Mindlin Plate theory*'.

Type of elements : 4 noded quadrilateral RM plate element (for good convergence use 64 or more elements mesh)

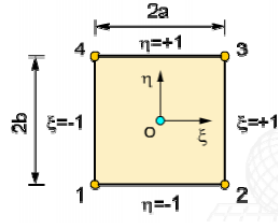

Where for RM element,

$$N_i = \frac{1}{4} \left(1 + \frac{\xi_i \xi}{a} \right) \left(1 + \frac{\eta_i \eta}{b} \right)$$

Integration Rule : We can use 4 point gaussian quadrature rule.

Node	(ξ, η)	N_i	$\frac{\partial N_i}{\partial x}$	$\frac{\partial N_i}{\partial y}$
1	(-1,-1)	$\frac{1}{4} \left(1 - \frac{\xi}{a} \right) \left(1 - \frac{\eta}{b} \right)$	$-\frac{1}{4} \frac{b - \eta}{a b}$	$-\frac{1}{4} \frac{a - \xi}{a b}$
2	(1,-1)	$\frac{1}{4} \left(1 + \frac{\xi}{a} \right) \left(1 - \frac{\eta}{b} \right)$	$\frac{1}{4} \frac{b - \eta}{a b}$	$-\frac{1}{4} \frac{a + \xi}{a b}$
3	(1,1)	$\frac{1}{4} \left(1 + \frac{\xi}{a} \right) \left(1 + \frac{\eta}{b} \right)$	$\frac{1}{4} \frac{b + \eta}{a b}$	$\frac{1}{4} \frac{a + \xi}{a b}$
4	(-1,1)	$\frac{1}{4} \left(1 - \frac{\xi}{a} \right) \left(1 + \frac{\eta}{b} \right)$	$-\frac{1}{4} \frac{b + \eta}{a b}$	$\frac{1}{4} \frac{a - \xi}{a b}$

Boundary conditions : Clamped at bottom of center plate, i.e.,

$$w = 0$$

$$\theta_x = \left(\frac{\partial w}{\partial x} \right) = 0$$

$$\theta_y = \left(\frac{\partial w}{\partial y} \right) = 0$$



Assignment 8.2

1. Patch test considering linear equation:

The linear equation that was considered for this patch test was ' $u=3x+2y+4$ '. At first an input file was created in order to give input for code 'Plate_MZC'. The geometry that was considered is square domain of 1×1 . This test was analysed for both structured and unstructured mesh and the results obtained was analysed in 'GID 12.0.4' and the results are shown below.

The following pictures show us the type of mesh and number of elements that has been considered for the patch test.

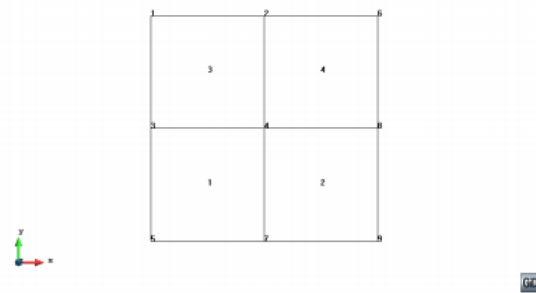

Figure 1: Structured Mesh.

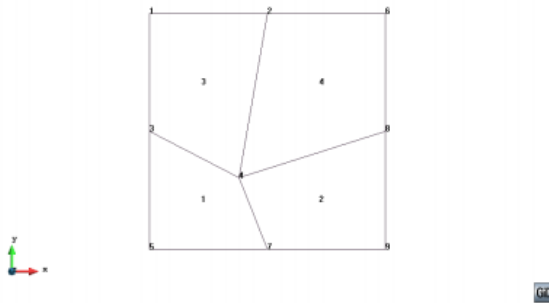

Figure 2: Unstructured Mesh.

Both in structured and unstructured mesh, node 4 which is at the middle are in the position $(0.5, 0.5)$ and $(0.379, 0.304)$ respectively. Now, the analytical displacements results obtained at this node 4 is 6.5 and 5.745 for both structured and unstructured mesh respectively and the rotation along x and y direction for both meshes are 3 and 2 respectively along x and y direction.

The results obtained in 'GID 12.0.4' for structured mesh was same as that of the analytical result which can be seen in *Figure 3*, where the value at the node 4 is exactly same as that of the analytical value that is 6.5.

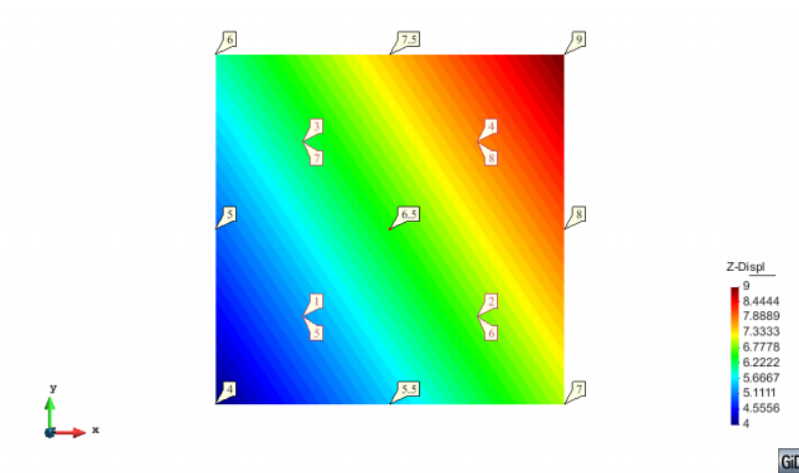

Figure 3: Displacement along Z for structured mesh.

The results obtained in 'GID 12.0.4' for unstructured mesh is different as that of the analytical result which has been shown in the *Figure 4* below, where the value at the node 4 is different as that of the analytical value that is 6.2587.

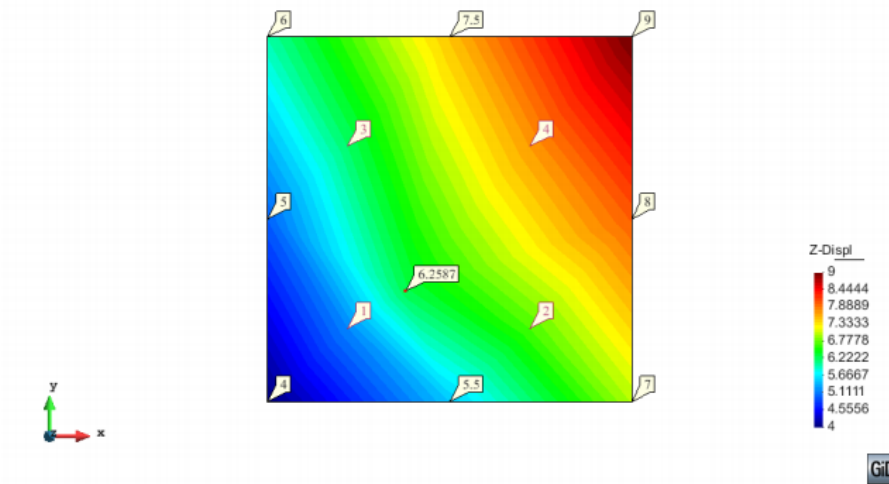

Figure 4: Displacement along Z for unstructured mesh.

When we take rotation in account, the values obtained after post processing is shown in the *Figures 5* below, where in it shows for structured mesh, the rotation values along x and y at node 4 is same as that of the analytical results.

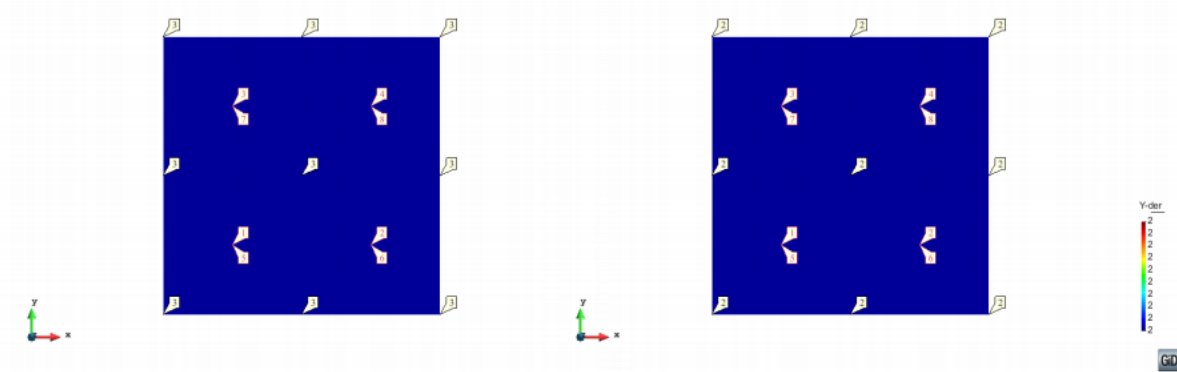

Figure 5: Rotation along X(left) and Y(right) for structured mesh.

But for unstructured mesh the rotation values along x and y at node 4 is different as that of the analytical results. which is shown in *Figure 6*.

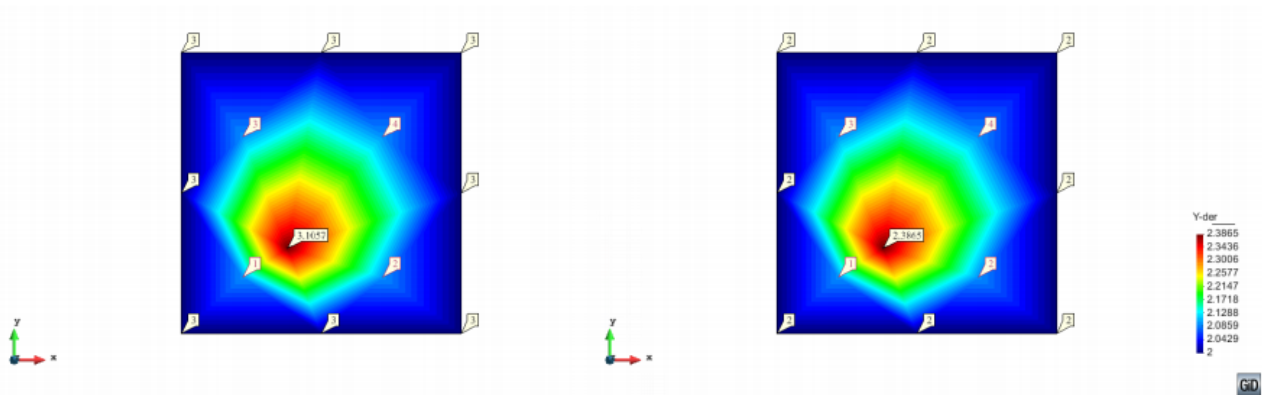

Figure 6: Rotation along X(left) and Y(right) for unstructured mesh.

2. Patch test considering quadratic equation:

The Quadratic equation that was considered for this patch test was $u = 3x + 2y + 4 + x^2 + y^2 + 2xy$. At first an input file was created in order to give input for code 'Plate_MZC'. The geometry that was considered is square domain of 1×1 . This test was analysed for both structured and unstructured mesh and the results obtained was analysed in 'GID 12.0.4' and the results are shown below. And it is to be noted that the type of mesh considered for quadratic polynomial is same as that of the linear equation.

Both in structured and unstructured mesh, node 4 which is at the middle are in the position $(0.5, 0.5)$ and $(0.37296, 0.300184)$ respectively. Now, the analytical displacements results obtained at this node 4 is 7.5 and 6.17239 for both structured and unstructured mesh respectively.

The results obtained in 'GID 12.0.4' for structured mesh, shows only the displacement along z direction was same at node 4 that is 7.5 but the rotation along x and y direction was different from obtained in analytical results. For structured mesh, the analytical results for rotation along x and y direction was 9 and 8 respectively. The below Figures 7 and 8 shows us the change in values compared with the analytical results for structured mesh.

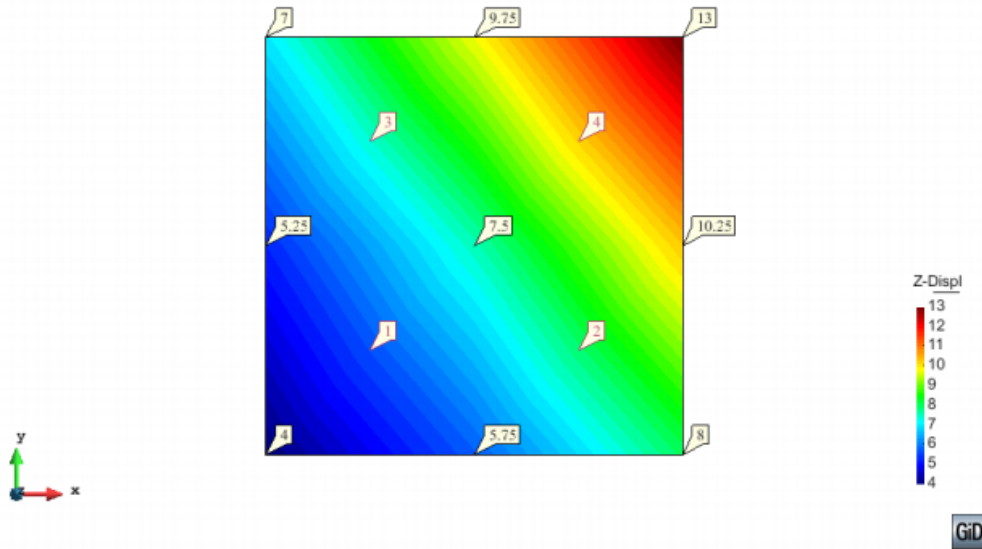

Figure 7: Displacement along Z for structured mesh.

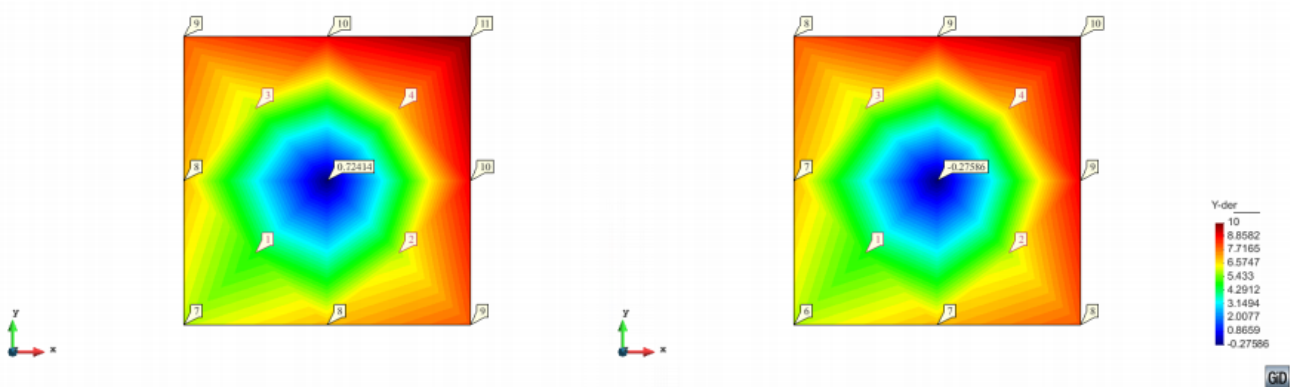

Figure 8: Rotation along X(left) and Y(right) for structured mesh.

Now the displacement along Z direction and rotation along X and Y direction for unstructured mesh is completely different when compared with analytical solution that has been computed. The analytical results are as follows: The

values of displacement along Z, rotation along X and rotation along Y are 6.17239, 8.3462 and 7.3462 respectively. The simulated images below show us the values that are obtained after post processing.

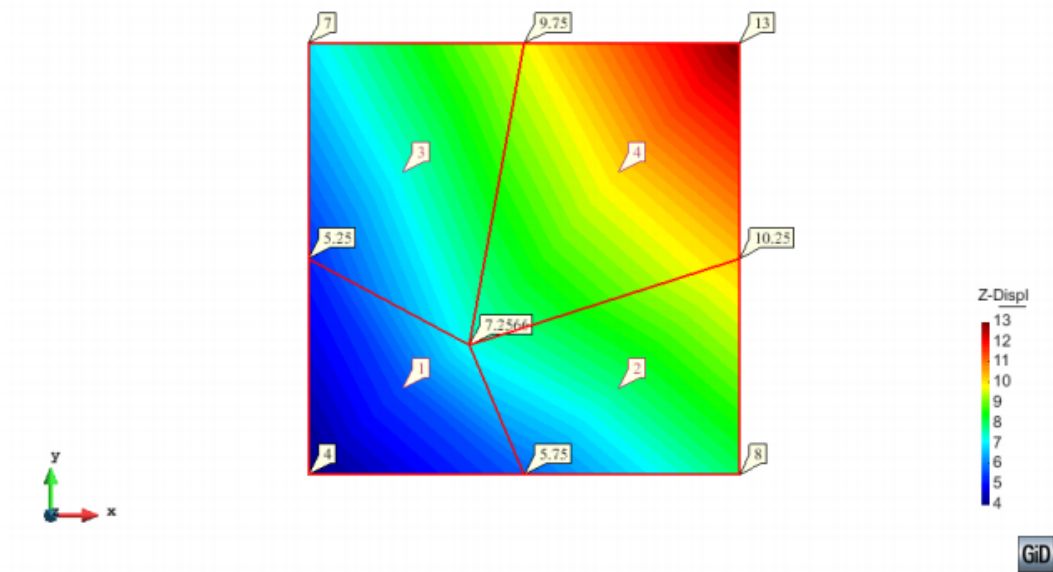

Figure 9: Displacement along Z for unstructured mesh.

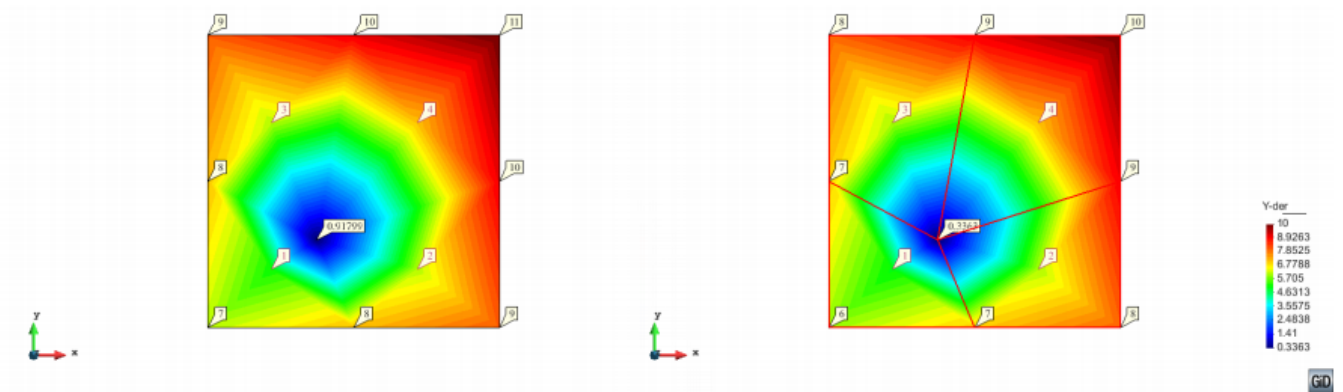

Figure 10: Rotation along X(left) and Y(right) for unstructured mesh.

To conclude patch test works good for linear equation with structured mesh, and it does not show proper response for linear unstructured, quadratic structured and quadratic unstructured. But accuracy would be better if we use 2nd order polynomial.