

**Master on Numerical
Methods in Engineering**

Computational Structural Mechanics and
Dynamics

Practice 4

Shells revolution

GiD and RamSeries (Rev_Shells) for
students vs Ramseries 15 professional
(3D solid) software

Mónica Ortega Castro

Exercise I: Cylindrical tank

Analyse the state of stress of the tank shown in the figure, which is submitted to an internal pressure. Suppose a continuous variation of the thickness of the spherical cupola. Use revolutions shell elements with two nodes and 3D shells elements with three nodes.

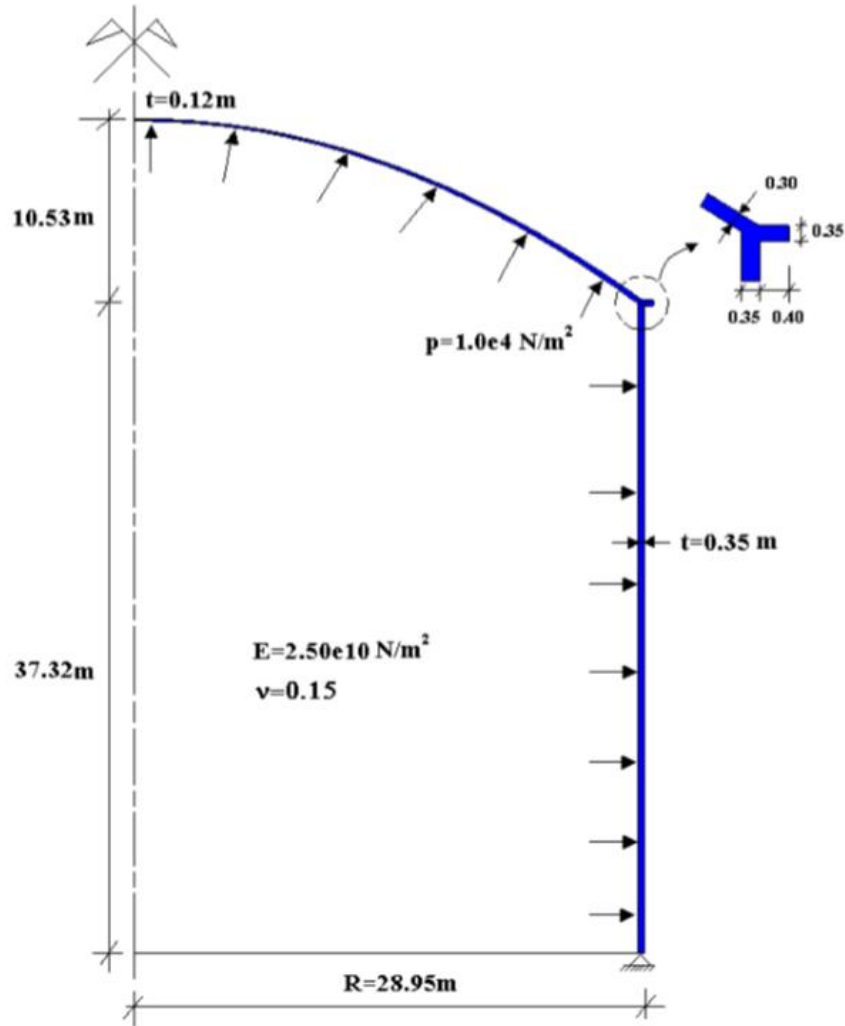

The aim of this study is to analyse the state of stress of the tank submitted to an internal pressure. This is done by Rev_shell (2D Ramseries) and 3D Ramseries. It is provided a quantitative stresses comparison between Shell_Rev and 3D solids (with symmetry conditions).

Report format is written as a comparison between both solutions. First part of the report will compare / state the geometric assumptions and equivalent boundary conditions applied. In the second part, related to mesh definition, it was chosen the most efficient mesh definition for a linear element in both cases. The convergence tolerance criteria is 0.00001 m for y-displacement. X-displacement is a lot more precise in both approaches and also related to the maximum element size. Results comparison considers displacement and stresses results.

Geometric definition

Continuous variation of the thickness of the copula was exerted when splitting it into 19 parts (lines or surfaces). Linear increment for each part was 0.0094736842 m to increase thickness from 0.12 m to 0.30 m. Constant 0.35 m thickness was applied to lines 100 and 101.

Geometry to simulate is symmetric. Thus, for simplicity reason and to save computational costs, 1/4 of geometry is computed.

In order to create the 3D geometry, 2D geometry was rotated 45° along Y-axis and extruded as surfaces.

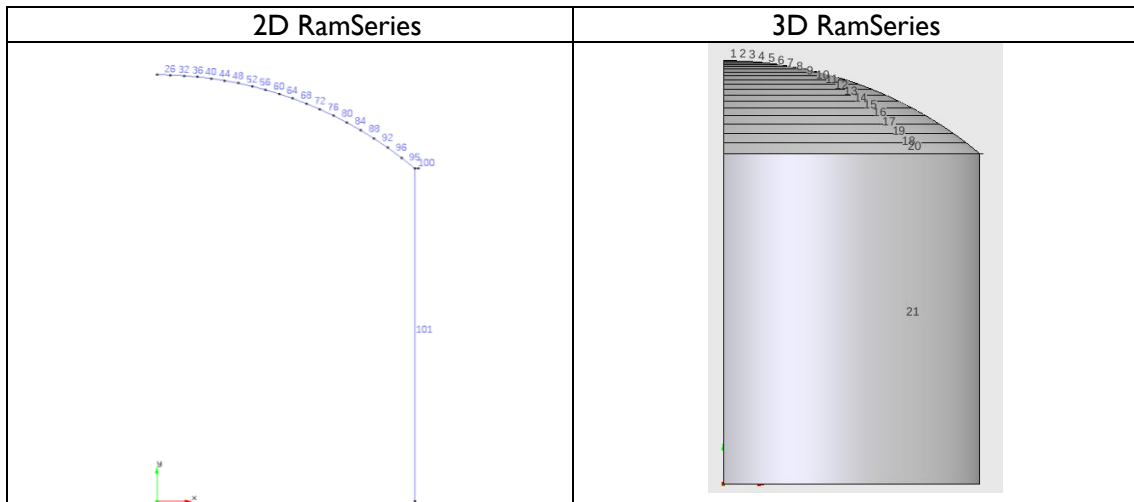

Figure 1. Geometry definition

Mesh convergence study

For 2D analysis, 2-noded element is used while for 3D a 3-noded element. Unstructured mesh was selected.

X and Y displacements are used as the parameters to test the element size. It is interesting to show numerical values for both (Table 1), 2D and 3D. This is because different mesh refinement provides the same tolerance results.

Max element size	nodes	x-disp 2D	y-disp 2D
0,5	115	0,0011173	0,0017387
0,25	151	0,0011154	0,0017443
0,1	213	0,0011154	0,0017500
0,01	386	0,0011151	0,0017582
		x-disp 3D	y-disp 3D
1	4399	0,0011061	0,0017646
0,8	6.720	0,0011128	0,0017714
0,9	5413	0,0011095	0,0017492
2	1322	0,0011120	0,0018068

Table 1. X-displacement and Y-displacement for different element size according to 2D or 3D simulations

The convergence tolerance criterion is 0.0001 m for y-displacement. X-displacement is a lot more precise in both approaches and related to the maximum element size.

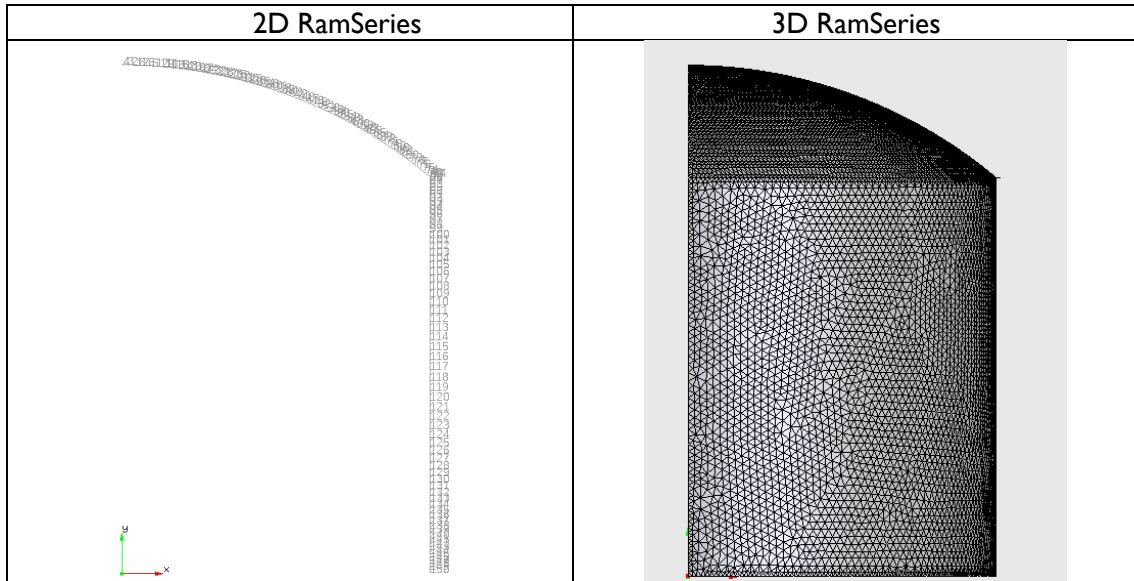

Figure 2. Mesh definition

Simulation data

Following Table 2 shows simulation conditions set to run both 2D and 3D RamSeries solutions.

	2D RamSeries	3D RamSeries
	y-axis must be the axis of revolution and it has to be (0, y).	y-axis must be the axis of symmetry and it must be (0, y, 0).
Fixed constraints	<ul style="list-style-type: none"> • Bottom node clamped • Upper node clamped due to symmetric reasons 	<ul style="list-style-type: none"> • Bottom line clamped • Boundary llines in XY-plane in X displacement and Y and Z rotations • Boundary llines in YZ-plane in Z displacement and X and Y rotations
Material properties	Beams, isotropic material as defined in exercise description. Thickness described above	Shells, isotropic material as defined exercise description. Thickness described above
Loadcases (local axis considered)	<ul style="list-style-type: none"> • Self-weight considered • Uniform load as normal pressure outwards 	<ul style="list-style-type: none"> • Self-weight considered • Uniform load as normal pressure outwards - Pressure at copula (0, 0, 1e4) N/m2 applied at each surface - Pressure at tank (0, 0, -1e4) N/m2 applied at the surface
Gravity vector in negative y-axis direction.		

Table 2. Simulation data

Results

When comparing both approaches, and considering an appropriate mesh definition, it is observed a similar behaviour for studied variables.

In general, outer deformation occurs. However, lack of constraints in line 100 (Figure 1), causes non-linear displacements outward whose ending point is line 100 shell (Figure 3). At the same time, latter shell caused rotating effects in near area (Figure 4).

In Figure 5 it is observed traction effects in copula as well as compression effect near tank foundation and shell from line 100.

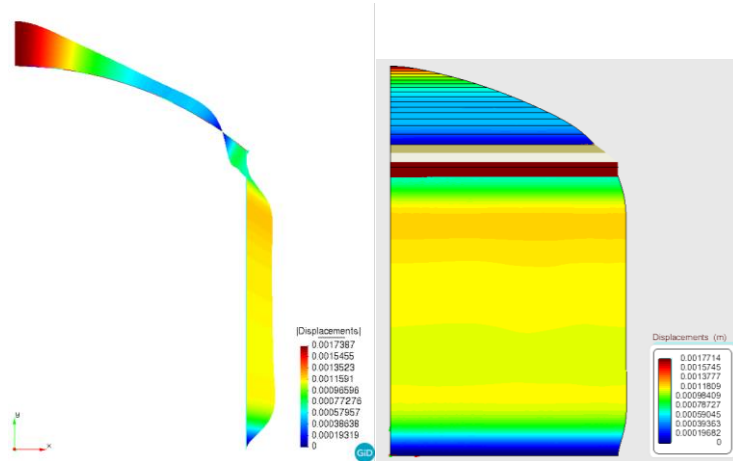

Figure 3. Module displacement comparison between shell revolution (Left hand side: 2D RamSeries - Vector line diagram) and 3D solids (Right hand side: 3D RamSeries – Contour fill)

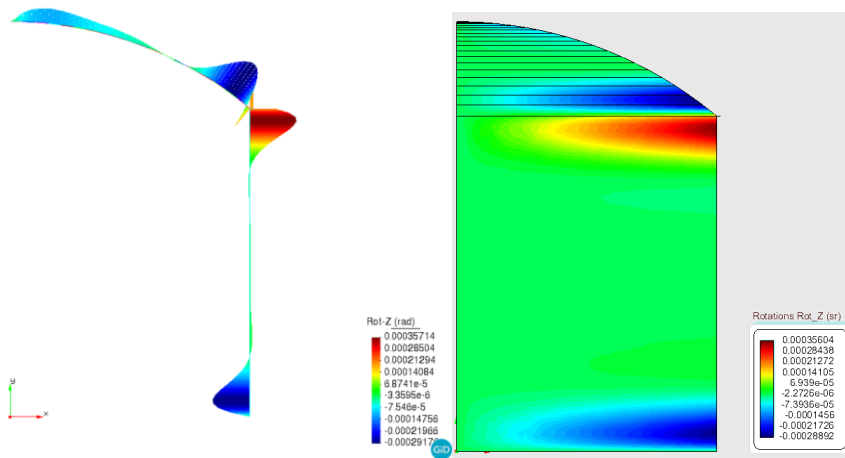

Figure 4. Z-rotation comparison between shell revolution (Left hand side: 2D RamSeries – axial stresses result surface) and 3D solids (Right hand side: 3D RamSeries – Contour fill)

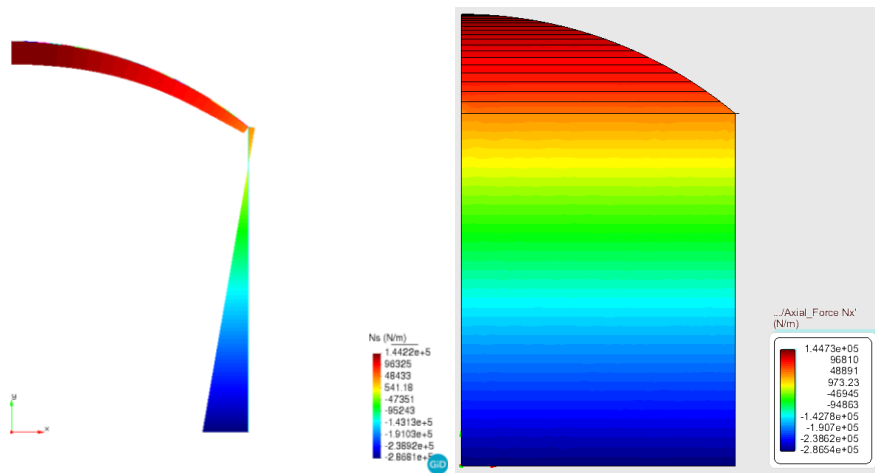

Figure 5. Axial forces comparison between shell revolution (Left hand side: 2D RamSeries – scalar line diagram) and 3D solids (Right hand side: 3D RamSeries – Contour fill)

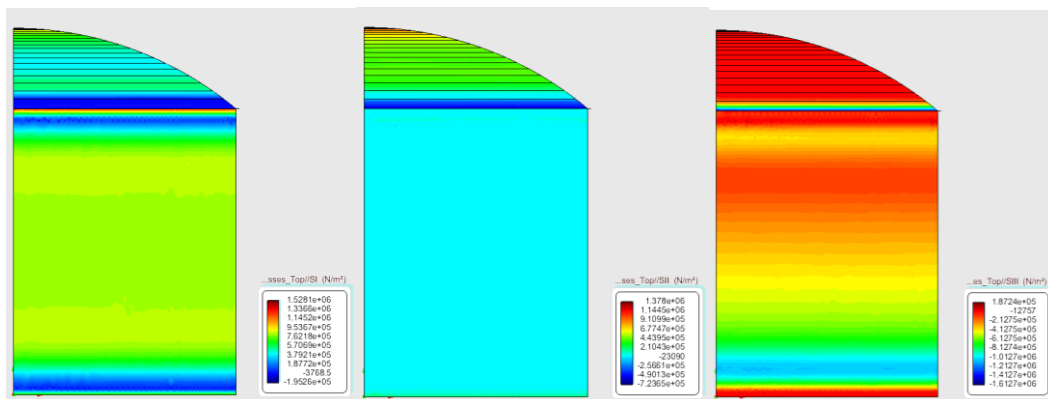

Figure 6. Axial forces comparison between shell revolution (Left hand side: 2D RamSeries – result surface) and 3D solids (Right hand side: 3D RamSeries – Contour fill)

Following images represent deformed structure shape for both approaches.

