

**Master on Numerical  
Methods in Engineering**

Computational Structural Mechanics and  
Dynamics

# Practice 5

Solid and structural dynamics

GiD and RamSeries 15 professional

Cases:

- Plane frame
- Spatial shell

Mónica Ortega Castro

---

### Exercise I: Plane Frame

Calculate the natural frequencies and modes of the plane frame in the figure. Perform a modal analysis and direct integration. Use a dynamic load frequency with the values  $\omega_p = 0.75\omega_1, 1.0\omega_1$  y  $1.25\omega_1$ , where  $\omega_1$  is the principal natural frequency.

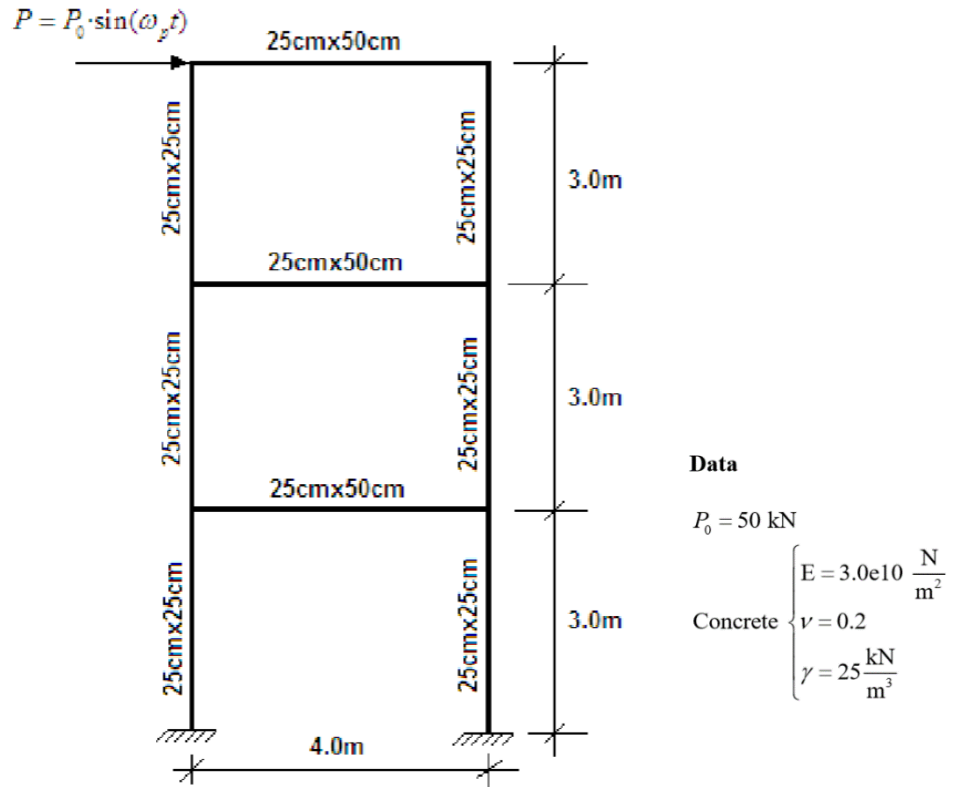

The aim of this study is to calculate natural frequencies and modes of the given plane frame. Modal analysis vs direct integration dynamic analysis types are compared.

In both analysis types (Figure 1) integration and damping settings were taking by default:

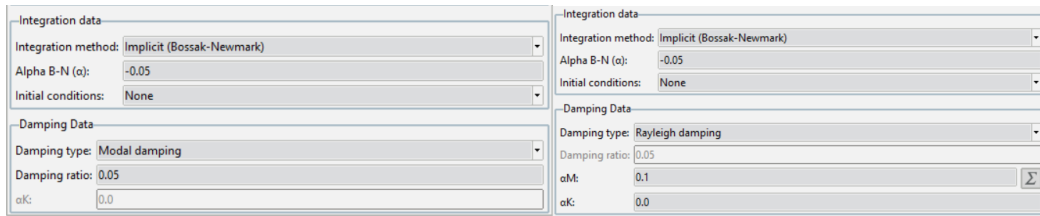

Figure 1. Integration and damping data for Modal analysis type (left hand image) and Direct integration type (right hand image)

The study is structured in 4 simulation:

Description	Modal analysis	Direct integration	Simulation conditions			
			Fixed constraints	Material properties	Self-weight	Punctual load

Simulation 1	Computation of natural frequencies for 10 modes. Mesh convergence study included			x	x		
Simulation 2	$W_p=0.75*W_I$	x	x	x	x	x	x
Simulation 3	$W_p=1.00*W_I$	x	x	x	x	x	x
Simulation 4	$W_p=1.25*W_I$	x	x	x	x	x	x

Table 1. Simulations structure

User defined problem is set up as:

- Beams
- Dynamic: modal analysis or direct integration
- Linear-elastic model
- Linear geometry
- 3D

Geometry and mesh definition:

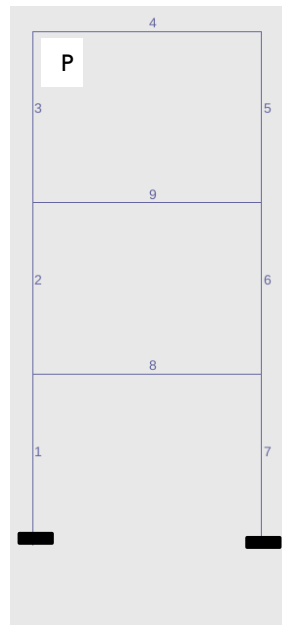

■ Clamped nodes

Figure 2. Structure geometry. Labelling

2-noded linear element were selected in an unstructured mesh.

Simulation conditions:

- Fixed constrains:
  - Two bottom nodes are fully clamped
  - The rest of the nodes are constrained at the z axis and x and y rotation
- Material properties are as defined on the problem description. Cross-section was defined as follow (Figure 2):
  - Beams 4, 9 and 8 are of  $0.25 \times 0.5 \text{ cm}^2$
  - Beams 1, 2, 3, 5, 6 and 7 are of  $0.25 \times 0.25 \text{ cm}^2$

- Self-weight considered
- Punctual loadcases as the problem requires was defined as follow:

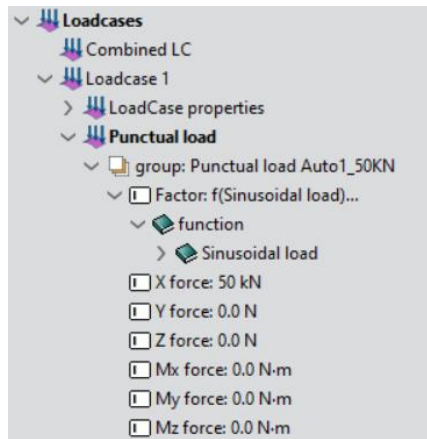

Figure 3. Punctual load features applied at node P

**Simulation I: Natural frequencies**

In order to compute natural frequencies, only fixed constraints and material properties were included and it was activated  Only calculate natural freqs.

Mode	Freq [Hz]	Mass_x [Kg]	Mass_x [%]	Mass_y [Kg]	Mass_y [%]	Mass_z [Kg]	Mass_z [%]
1	4.229	5647	84.3840	6.506e-021	0.0000	7.894e-029	0.0000
2	12.56	586.3	8.7612	4.895e-022	0.0000	7.476e-029	0.0000
3	19.6	105.3	1.5731	2.482e-020	0.0000	1.959e-029	0.0000
4	43.29	1.446e-019	0.0000	4071	60.8396	1.885e-026	0.0000
5	48.18	5.322e-019	0.0000	353.2	5.2775	8.768e-027	0.0000
6	52.53	2.973e-019	0.0000	682.8	10.2035	2.229e-025	0.0000
7	54.99	1.567e-031	0.0000	2.501e-025	0.0000	10.07	0.1504
8	54.99	1.57e-029	0.0000	4.918e-027	0.0000	6.335	0.0947
9	54.99	7.206e-030	0.0000	2.438e-025	0.0000	2613	39.0408
10	74.16	0.3603	0.0054	3.572e-017	0.0000	7.97e-028	0.0000

Figure 4. Natural frequencies

- Mesh convergence study

Maximum y-displacement for Mode I (f=4.229 Hz) was the parameter to measure the convergence. Tolerance was settled as 0.000001. Selected element size is 0.035 m (Graphic I).

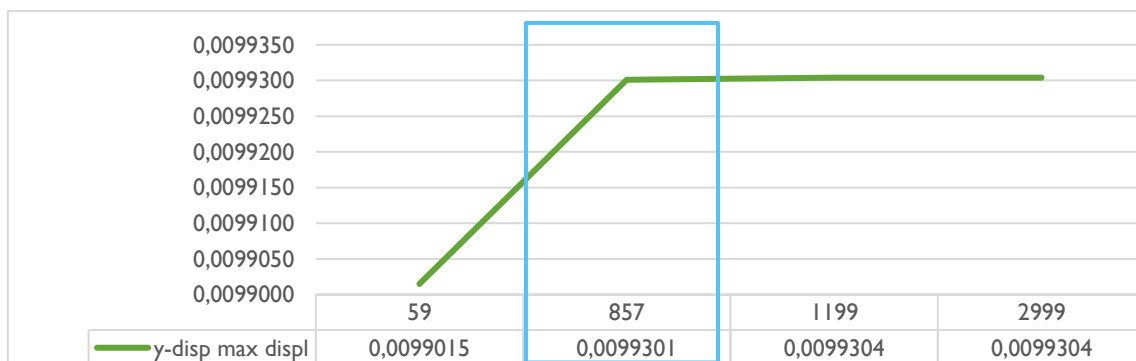

Graphic I. y-displacement and nodes. Mesh description comparison

**Simulations 2, 3 and 4: Dynamic structural analysis with  $W_1$**

Principal natural frequency (f)	4.229 Hz
Angular natural frequency ( $W_1$ )	26.57159066 rad/s

$W_p=$	Factor	$W_p$	Natural frequency	$T=1/f$	$A_t$	Steps number for 1 second
$0.75 \cdot W_1$	0.75	19.928693	3.17175			
$1 \cdot W_1$	1.00	26.5715907	4.229	0.2364625	0.01182313	84.58
$1.25 \cdot W_1$	1.25	33.2144883	5.28625			

Table 2. Simulation data

$W_p$ : Dynamic load frequency of vibration [rad/s]

$W_i$ : Natural frequencies of vibration [rad/s]

$W_1$ : Principal natural frequency [rad/s]

Time increment and step number for case  $W_p=1 \cdot W_1$  were applied to the three cases. This, with the aim of comparing results for same.

Results are compared at P point which is the node where load is applied thus, due to displacement experience it is expected higher x-displacement values as it is represented in Graphic 2.

It is concluded that vibration frequency behaves as follow:  $1.25W_p < 0.75W_p < 1.00W_p$ . Also, wave amplitude for  $1.00W_p$  case increases as time passes while for the remaining cases peak is higher in the middle and decreases as at the end of the time simulation.

When comparing modal vs direct integration analysis type, it is observed values are, in general, higher for the latter.

Same pattern behaviour for both analysis types.

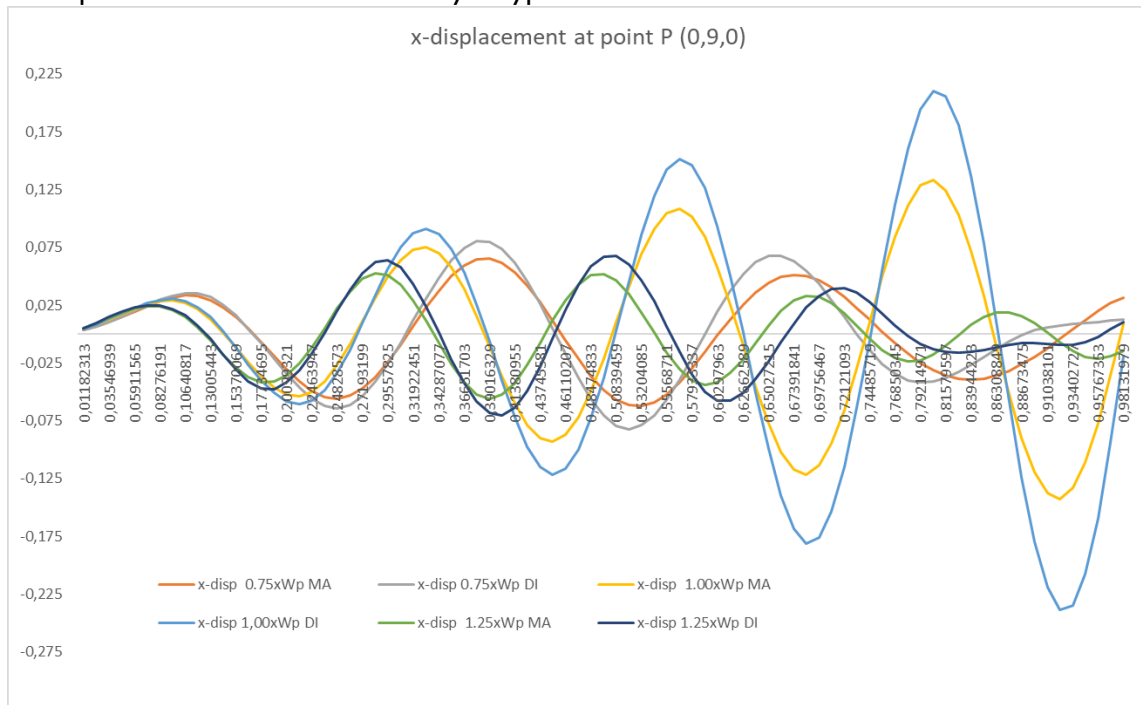

Graphic 2. Horizontal displacement at the punctual load application point

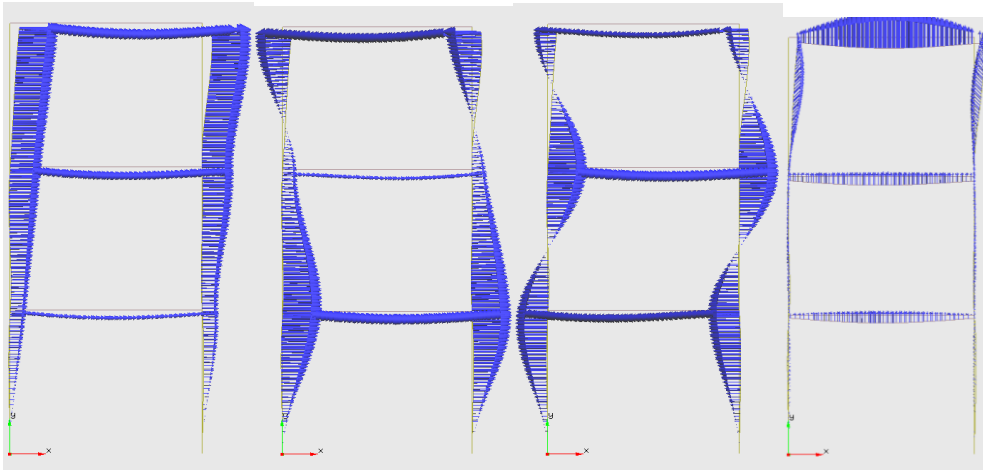

Figure 4. Mode 1, mode 2, mode 3, mode 4

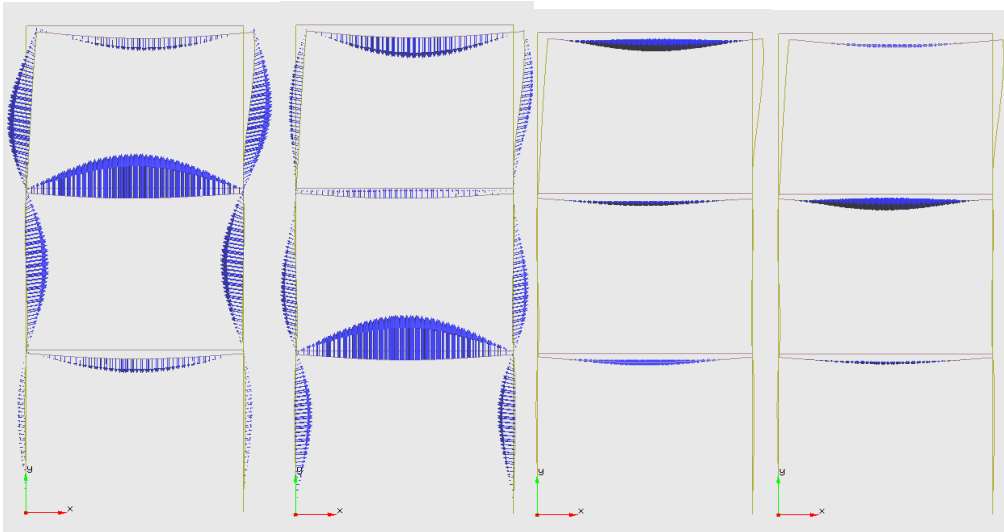

Figure 5. Mode 5, mode 6, mode 7, mode 8

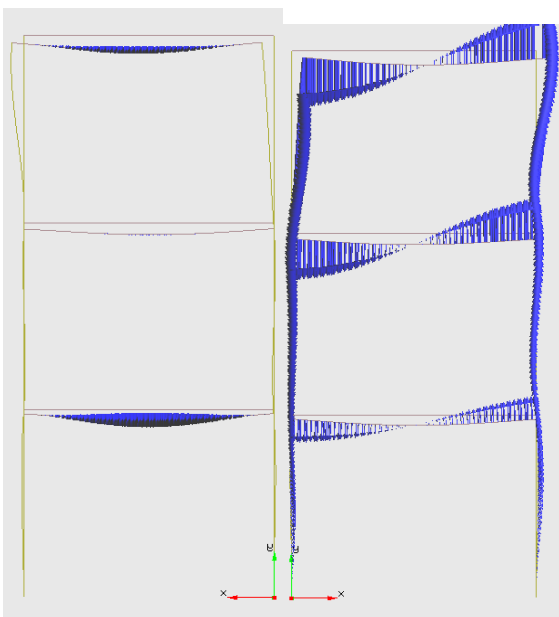

Figure 6. Mode 9, mode 10

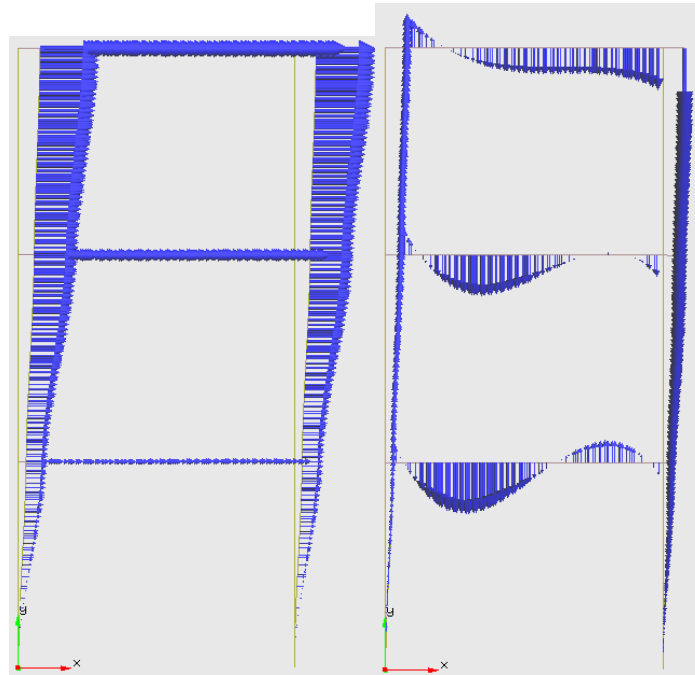

Figure 4. Dynamic vectoral representation of displacement (l.h.s x-displacement, r.h.s. y-displacement)

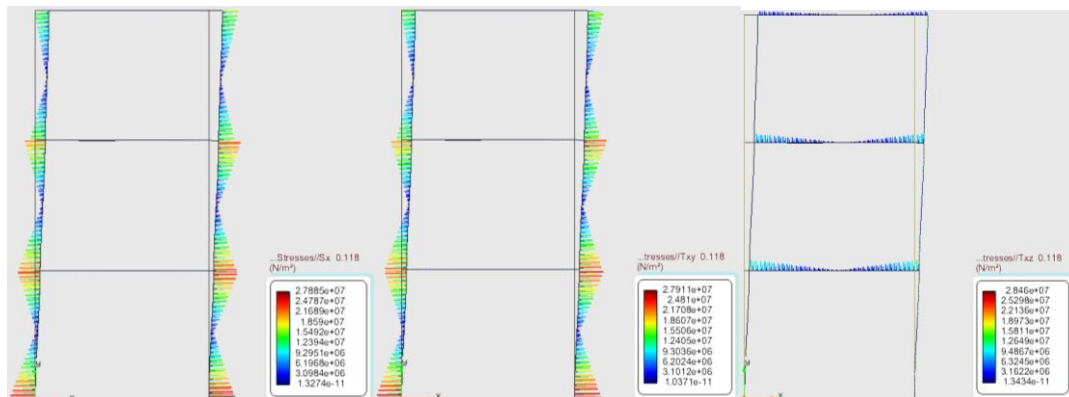
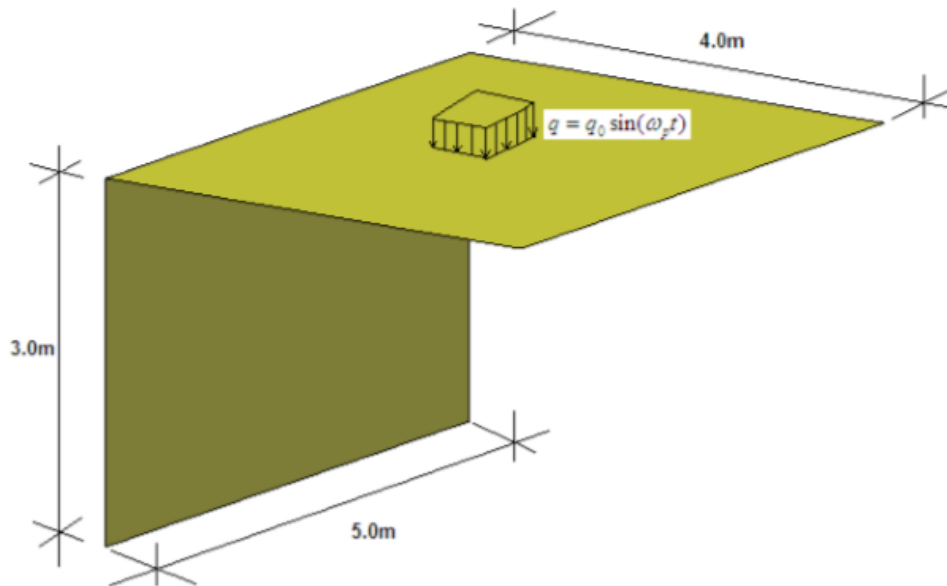

Figure 5. Max stresses representation

### Exercise 2: Spatial shell

Calculate the natural frequencies and modes of the spatial shell in the figure. Perform a modal analysis and direct integration. Use a dynamic load frequency with the values  $\omega_p = 0.75\omega_1, 1.0\omega_1$  y  $1.25\omega_1$ , where  $\omega_1$  is the principal natural frequency.



#### Data

$$q_0 = 50 \frac{\text{kN}}{\text{m}^2}$$

$$\text{Concrete} \begin{cases} E = 3.0 \times 10^{10} \frac{\text{N}}{\text{m}^2} \\ \nu = 0.2 \\ \gamma = 25 \frac{\text{kN}}{\text{m}^3} \\ t = 0.30 \text{ m} \end{cases}$$

The aim of this study is to calculate natural frequencies and modes of the given spatial shell. Modal analysis vs direct integration dynamic analysis types are compared.

In both analysis types (Figure 1) integration and damping settings were taking by default (Figure 1 from Exercise 1).



The study is

structured in 4 simulation (See Table 1):

	Description	Modal analysis	Direct integration	Simulation conditions			
				Fixed constraints	Material properties	Self-weight	Distributed load
Simulation 1	Computation of natural frequencies for 10 modes. Mesh convergence study included			x	x		
Simulation 2	$W_p=0.75*W_I$	x	x	x	x	x	x
Simulation 3	$W_p=1.00*W_I$	x	x	x	x	x	x
Simulation 4	$W_p=1.25*W_I$	x	x	x	x	x	x

Table 1. Simulations structure

**User defined problem is set up as:**

- Shells
- Dynamic: modal analysis or direct integration
- Linear-elastic model
- Linear geometry
- 3D

**Geometry and mesh definition:**

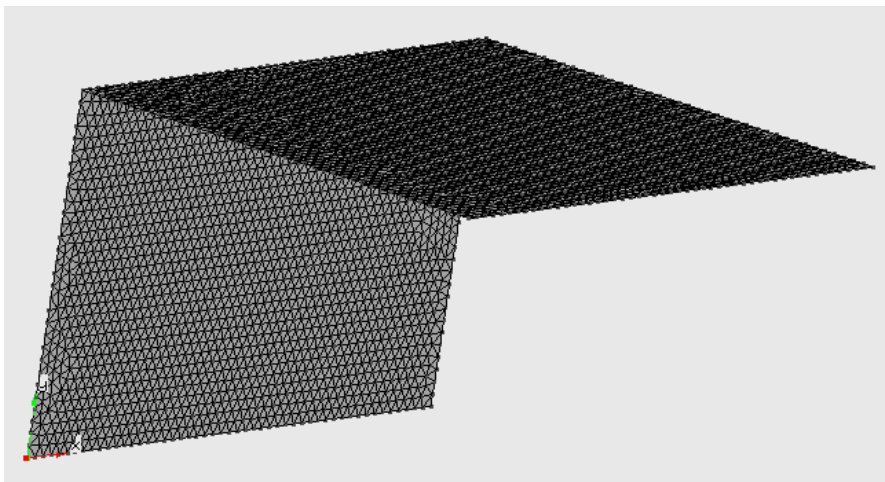

Figure 2. Structure geometry

3-noded linear element were selected in an unstructured mesh.

Simulation conditions:

- Fixed constrains:
  - Clamped line along x-axis
- Material properties are as defined on the problem description
- Self-weight considered
- Distributed load was applied at the shell located at the XY plane

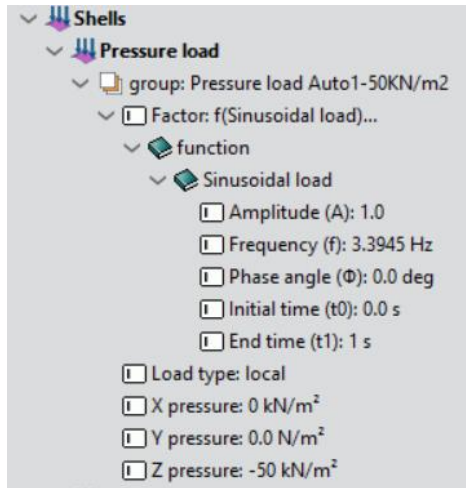

Figure 3. Distributed load features applied at node XZ-plane shell.  $W_p=0.75*W_I$  case

**Simulation I: Natural frequencies**

In order to compute natural frequencies, only fixed constraints and material properties were included and it was activated  Only calculate natural freqs.

Mode	Freq [Hz]	Mass_x [Kg]	Mass_x [%]	Mass_y [Kg]	Mass_y [%]	Mass_z [Kg]	Mass_z [%]
1	4.526	8.064e-008	0.0000	7937	29.6526	6012	22.4595
2	8.852	7753	28.9626	6.865e-009	0.0000	1.1e-008	0.0000
3	12.65	5.951e-008	0.0000	2456	9.1755	1.576e+004	58.8746
4	20.23	225.3	0.8416	3.79e-006	0.0000	8.928e-007	0.0000
5	51.45	2.631e-007	0.0000	2279	8.5141	519.7	1.9414
6	57.14	2.149e-007	0.0000	502	1.8754	106.7	0.3985
7	73.1	354.4	1.3240	6.526e-007	0.0000	6.109e-006	0.0000
8	83.83	1.267e+004	47.3237	1.263e-008	0.0000	1.076e-006	0.0000
9	104.2	1.661e-005	0.0000	70.66	0.2640	1769	6.6082
10	116.1	803.6	3.0020	5.516e-005	0.0000	2.933e-007	0.0000

Figure 4. Natural frequencies

- Mesh convergence study

Maximum y-displacement for Mode I ( $f=4.526$  Hz) was the parameter to measure the convergence. Tolerance was settled as 0.0001. Selected element size is 0.125 m (Graphic I).

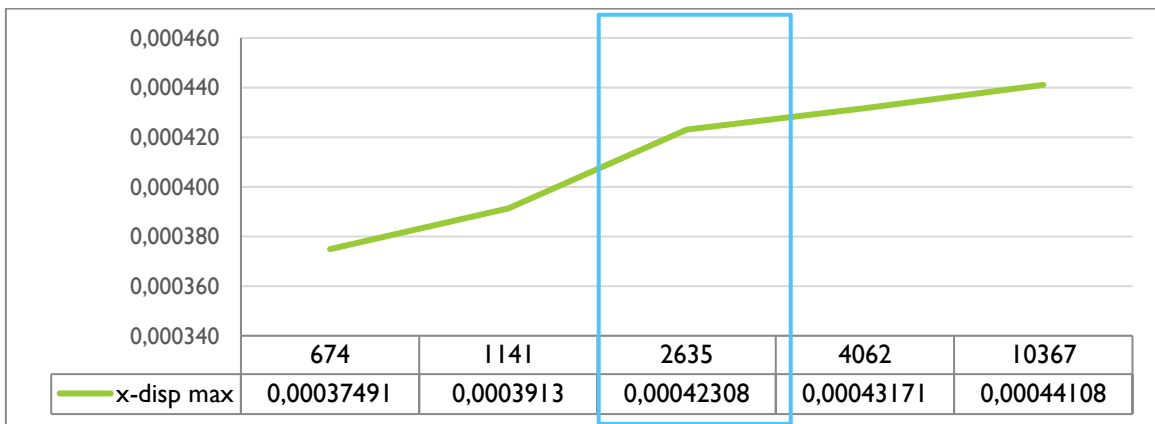

Graphic I. y-displacement and nodes. Mesh description comparison

**Simulations 2, 3 and 4: Dynamic structural analysis with  $W_1$**

Principal natural frequency	4.526 Hz
Angular natural frequency ( $w_1$ )	28.4376967 rad/s

Wp=	factor	Wp	f=w/2pi	T=1/f	At	Steps number
0.75*W1	0.75	21.3282725	3.3945	0.22094565		
1.00*W1	1.00	28.4376967	4.526	0.22094565	0.01104728	91
1.25*W1	1.25	35.5471209	5.6575	0.22094565		

Table 2. Simulation data

In this shell's case, it was considered more appropriate to evaluate maximum and minimum displacement in y direction.

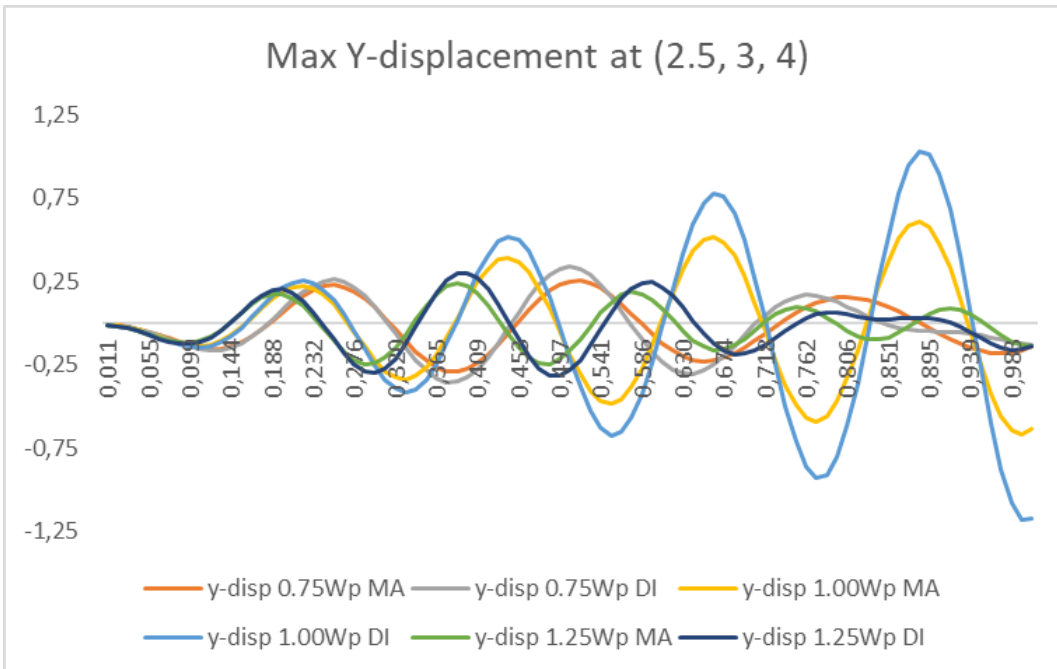

Graphic 2. Max y-displacement. Time plot for 1 second of simulation

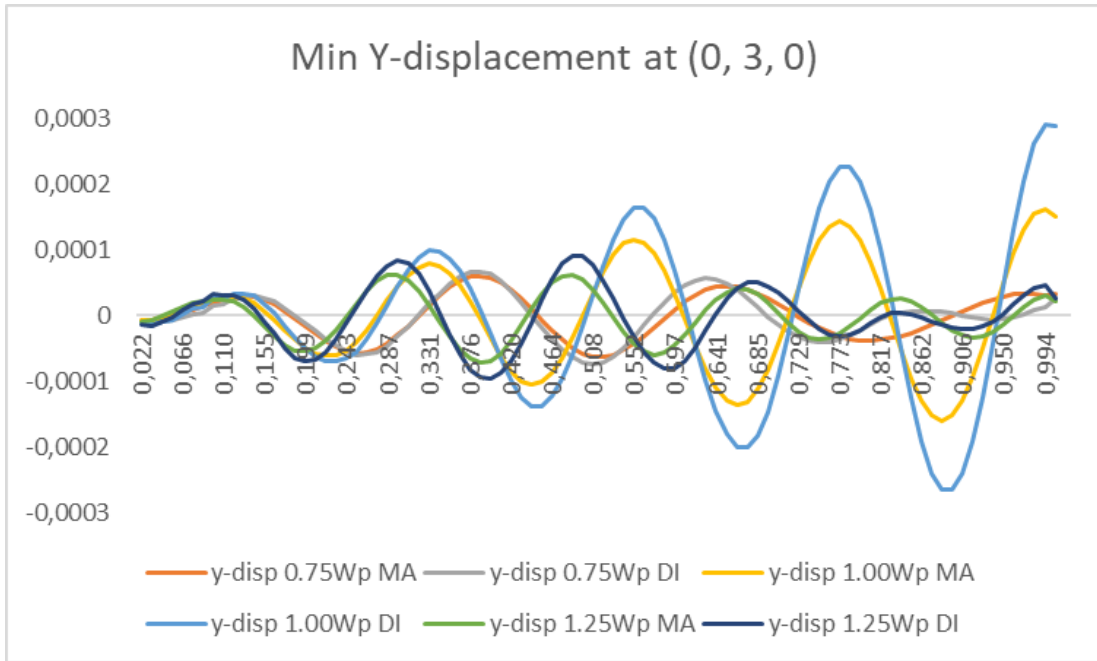

Graphic 3. Min y-displacement. Time plot for 1 second of simulation

Based on results, same behaviour from frequencies of vibration (at in Exercise I) than in Exercise I. The structure responds to load frequencies of vibration as follow:

$$1.25Wl < 0.75Wl < 1.00Wl$$

Wave amplitude for 1.00Wp case increases as time passes while for the remaining cases peak is higher in the middle and decreases as at the end of the time simulation. Resonance will occur for  $Wp = l * Wl$  case.

When comparing modal vs direct integration analysis type, it is observed values are, in general, higher for the latter. Same pattern behaviour for both analysis types.

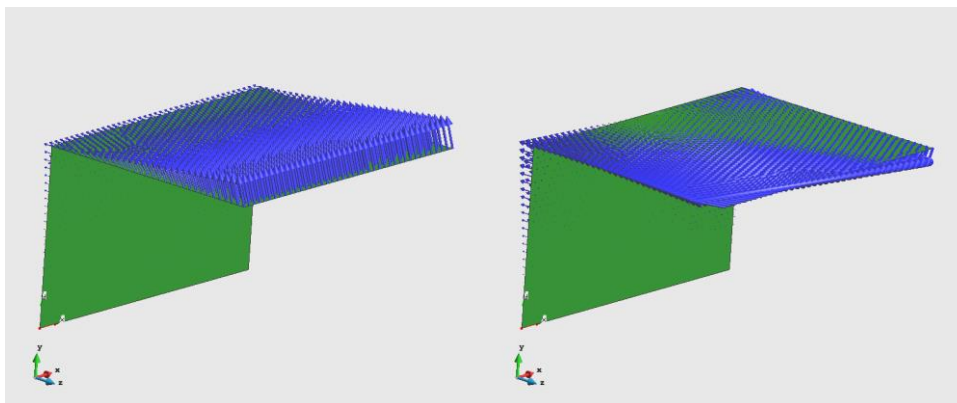

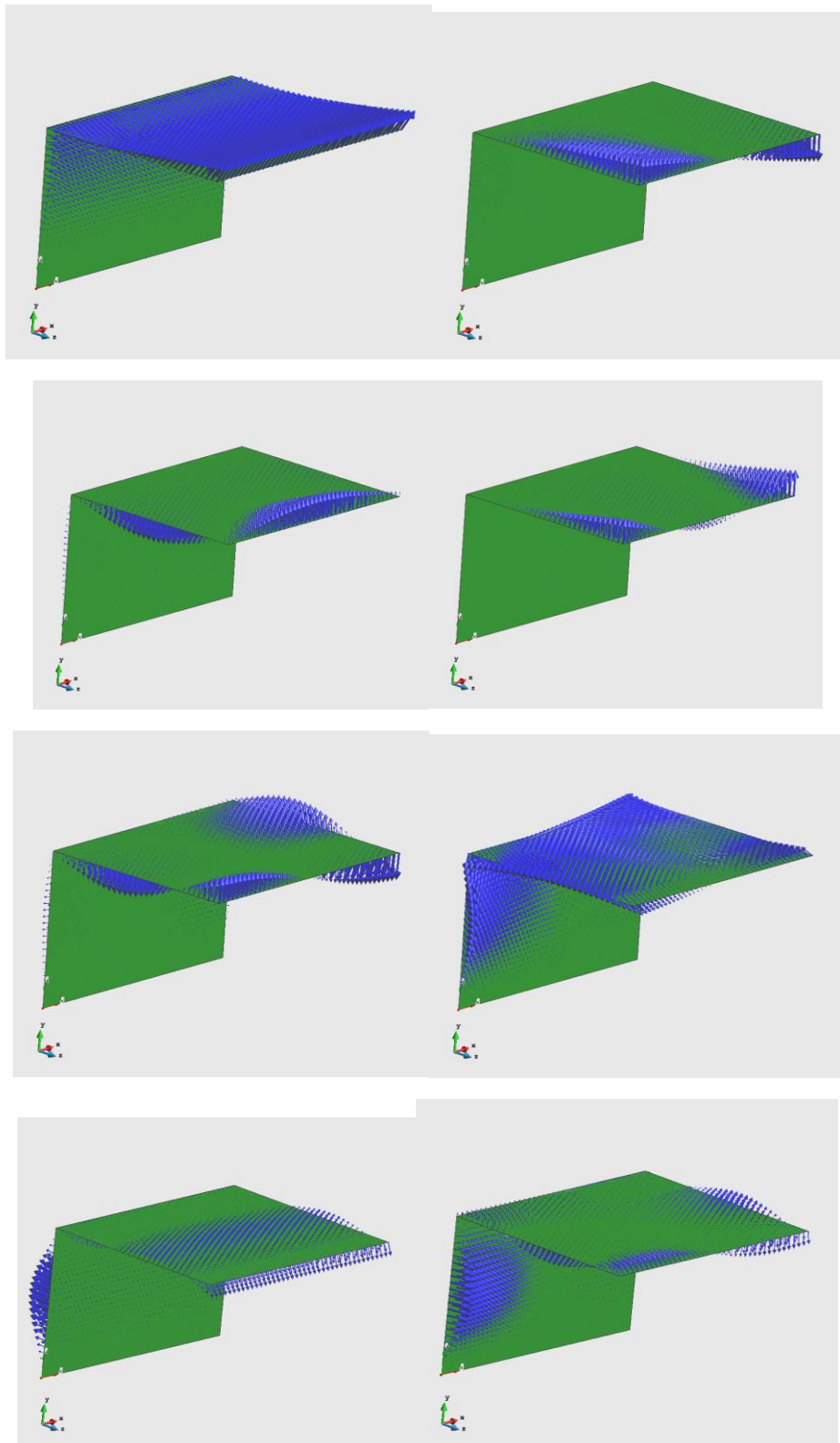

Figure 3. Modes 1 to 10